

EFFECT OF MINERAL ADMIXTURES ON CORROSION RESISTANCE OF REINFORCED STEEL RODS IN CONCRETE

Fatima A. Al-Qadri¹ and Ali Al-Qubati²

¹ Associate professor, Department of Chemistry, Sana'a Yemen University, Aldaree street, P.O. Box 11923. Sana'a Yemen, Email: f_alkadri@gmail.com

² Sana'a University, Chemistry Department

(Received January 19, 2012 Accepted June 23, 2012)

Mineral admixture is widely used in concretes with less water-cement ratio, to improve some properties like strength and workability. In addition, this admixture has effect on corrosion resistance of embedded re-bars in concrete. In this work, the corrosion rate of mild steel rod, TMT (Thermo Mechanically Treated) rod were observed by adding mineral admixtures in M25 concrete mix. The percentage of admixtures were 3%, the study was carried out for a period of 15 months. The corrosion rates were measured at different intervals by conducting electrochemical tests like ACI test, and by weight loss test (gravimetric method). In most of the time and cases, the corrosion rate was found to be less for 3% of mineral reducing admixtures. Corrosion resistance of TMT rod is better in the presence of mineral admixtures.

Keywords: Mineral admixtures, concrete, steel rod, corrosion, resistance.

1. INTRODUCTION

Concrete is a composite material made of aggregates and porous cement paste, which is the reaction product of mixing water and cement. The structure and composition of cement paste determines the long term performance (durability) of concrete. Concrete is normally reinforced with steel rods. The reinforcing steel rods provide strength and ductility only through the bond strength and anchorage to the concrete [1, 2]. The effectiveness of bond and anchorage is reduced due to the deterioration of concrete, steel or both. The durability of concrete structure depends on the resistance of concrete against physical and chemical attack and its ability to protect the embedded reinforcement against corrosion.

Corrosion in general is the destruction or deterioration of a material because of the reaction with its environment [3]. Large number of existing structures is being damaged with time by reinforcement corrosion due to environmental exposure and changes. Reinforcement corrosion is a dangerous activity that takes place in the re-bars of the concrete structures, leads to delamination because of the expansive action of corrosion product [4].

Corrosion control of steel reinforced concrete can be done by various methods like steel surface treatment, use of admixture in concrete and cathodic protection. Among all the previous methods, mixing admixture with concrete is very effective and cheaper, when comparing to other methods [5].

Admixtures which are used primarily for structural property improvement can be by minerals like fly ash, blast furnace slag, silica fume, methyl cellulose, carbon fibers or by solid particle dispersions such as latex [6]. Preparing dense and impermeable concrete by reducing water-cement ratio can prevent the reinforcement corrosion [7, 14, 15, 16, and 17]. Adding mineral admixtures like silica fume with Blast furnace slag with concrete improved the compressive strength, capillary efficiency and corrosion current density, but the slump of the concrete is decreased [9,10,13]. Many experiments were done to study the strength properties and corrosion resistance behavior of concrete by adding mineral admixtures like fly ash and blast furnace slag etc., the corrosion resistance of concrete with rebar by adding chemical admixtures in fresh concrete, other than nitrates has not been reported so far [23, 24].

The objective of this study is to investigate the corrosion resistance of reinforced M25 concrete mix with 3% percentage of mineral admixtures i.e. water reducing admixtures. The standard specification of using Mineral admixtures in concrete is followed as per ASTM, C 494/C 494 M-05 [21]. Corrosion rate on mild steel rod, measured by chemical tests called ACI test, and by weight loss test (destructive test).150x150x150 mm cubes were cast with 0%, 0.5%, 0.75%, 1% and 1.25% in triplicate for all the tests and the average of corrosion rate were plotted against time. The effect of addition of mineral admixtures on corrosion resistance of rebar is compared. Corrosion rate is indirectly proportional to the resistivity offered by the concrete to the applied current, which, in turn depends on the property of concrete [22].

2. EXPERIMENTAL PROGRAM

2.1 Materials

Table 1. Properties of materials used.

S. No.	Material	Properties	Remarks
1	Cement,	Specific Gravity- 3.06	43 grade-O.P.C Yemeni, Sudani, and Egyptian.
2	Fine aggregate	Specific Gravity- 2.67 Fineness modulus- 2.52	Red sea , and Arabic sea sand, Hodeida and Aden ,Yemen.
3	Coarse aggregate	Specific Gravity= 2.78 Fineness modulus= 7.28. Bulk density=1523 kg/m ³	Local Quarry, Am ran .
4	Water	Potable- as per IS 456-2000	Red sea , and Arabic sea sand, Hodeida and Aden ,Yemen.
5	Mineral admixtures-	Fly ash , and Silica fume	Obtained from a chemical supplying company, Bangalore, India.
6	Reinforcement TMT rod	10mm Dia,76mm long, Mild Steel, Thermo mechanically treated, Cold twisted deformed Rebars- Fe 415	Obtained from a steel producing company in Turkey.

2.2 Concrete Mix Design

As per ACI 211-1-91, M25 concrete mix was designed with the water cement ratio of 0.43. The proportion of ingredients by weight of cement content = 1: 2.31: 2.57: 0.43. After 28 days of curing, the actual strength of M25 grade concrete obtained was 34.27 N/mm for this mix proportion.

The water-cement ratio was kept to be 0.43. For this, following systems:

- 1- 43g cement + 100 g water
- 2- 42.7 g cement + 0.3 g fly ash + 100 g water
- 3- 42.7 g cement + 0.3 g silica fume + 100 g water

Silica fume content %	Fly ash content%	W/C Water cement ratio
-	-	0.43
0.3	-	0.43
-	0.3	0.43

2.3 Preparatory Work for Steel Rods

As per ASTM G1-03 [18], the rods were cleaned by a pickling solution for the removal of unwanted deposits or rust over the surface of the rods. The pickling solution comprises 500 ml concentrated hydrochloric acid, 500 ml distilled water and 3.5 gm of hexamethylene tetramine (Hexamine). After cleaning weights of rods (initial weight) were taken in an electronic balance with four decimal accuracy because the weight of the corrosion product comes in milligrams.

The rods meant for electrochemical tests are connected by copper wires at one end. For firm fixing, rods are drilled at 1 inch from one end and the copper-mild steel connection up to the drill of 1 inch was sealed with epoxy material for avoiding galvanic corrosion between mild steel rod and copper wire. Then the rods are suspended vertically inside the cube mould so as to have 1” cover at the top and bottom. The admixtures added to concrete was poured and compacted well. All the cubes are kept at room temperature for 24 hrs and then demoulded for placing them in water for curing. After 28 days of curing, the cubes are subjected to alternate wetting and drying so as to get accelerated corrosion. The cubes were ponded with 3% (by mass of water) sodium chloride (NaCl) solution. Electrochemical tests of ACI, and the gravimetric test of weight loss were conducted periodically for every three months. Cubes with rods and without wires were cast separately for weight loss test. Since the initiation of corrosion over rebar was slow, readings were taken only after six months of casting (5 months after curing).

2.4 Methodology

2.4.1 AC impedance test

AC Impedance technique is an electrochemical non-destructive technique to quantify the corrosion of steel re-bars embedded in concrete [8]. Impedance ‘Z’ is the ratio of A.C. Voltage (ΔE) to A.C. current (ΔI). In this technique an alternating voltage (ΔE) of 20 mV is applied to the rebar and the resultant current (ΔI) and phase angle (Φ) are measured for various frequencies. The general electrical circuit system is shown in Fig.1.

The response to A.C. input is a complex impedance that has both real (resistive) Z' and imaginary (capacitive or inductive) Z'' . From studying the variation of the impedance with frequency, an equivalent electrical circuit can be determined which will give the same response as the corrosion system being studied.

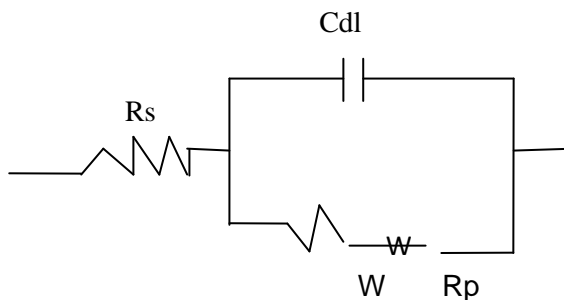

Fig. 1: Electric circuit

where,

R_s - Solution resistance;

R_p - Polarization resistance

C_{dl} - Double layer capacitance;

W - Warberg's Impedance

In this electrochemical, 3-electrodes system, the embedded rebar acts as working electrode, stainless steel plate acts as counter electrode and the saturated calomel electrode (silver- silver nitrate) acts as reference electrode. Concrete surrounding the rebar is the electrolyte and all the things are kept wet for effective conduction of current between them. The three electrodes are connected to the electro-chemical analyzer CHI604C.

2.4.2 Weight loss test (Gravimetric Technique)

This destructive technique involves weighing of re-bars before and after embedding into the concrete. Cleaning the rebar by a pickling solution and evaluation of rate of corrosion are done as per ASTM G1-03 [19]. Periodically the concrete cubes are broken open and the rods are taken out for weighing. Before weighing, the rods are cleared with the pickling solution, so that there must not be any sticky concrete particles over the surface of re- bars. Pickling solution consists of 500 ml hydrochloric acid + 500 ml distilled water + 3.5 grams of hexamethylene tetramine. The rods are weighed with a electronic balance of 4 decimal accuracy and the final weights are compared with the initial weights of rods before embedment. The loss of weight due to corrosion

is calculated from the weight loss, and the corrosion rate is calculated by the formula [8] as:

$$\text{Corrosion rate} = KW / ATD \text{ (mm/yr)}$$

where,

K = A constant = 8.76×10^4 ; W = Weight loss in gm
 T = Exposure time in hours; A = Surface area in cm^2
 and D = Density of the rod (7.85 gm/cm^3).

3. RESULTS AND DISCUSSIONS

3.1 AC Impedance Measurement Test of TMT Rod:

TMT rod

Figure 2 shows that in the 4 th month, corrosion rate of TMT rod in concrete without admixtures is higher than all the specimens in concrete mixed with admixtures. The corrosion rate decreases for concrete without admixtures when the duration increases. The corrosion rate of TMT rods with respect to admixtures silica fume and fly ash additions are shown in Figs. 3 and 4 . From these figures it is depicted that here also the corrosion rate decreases for all cases because of the breakdown of passive film only after 11th month admixed concrete. At 15th month, corrosion rate of TMT rod embedded in concrete without admixtures shows higher corrosion rate than the rods of admixed concrete. In all the times corrosion rate of TMT bar in concrete admixed with silica fume is observed less with respect to the other admixture which was fly ash.

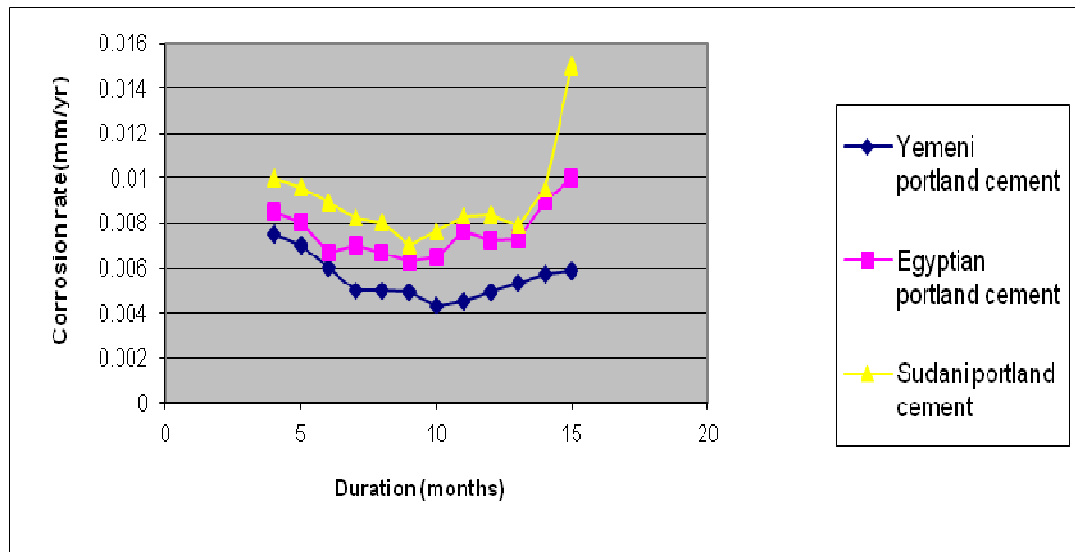

Fig. 2: ACI test results-TMT without admixtures

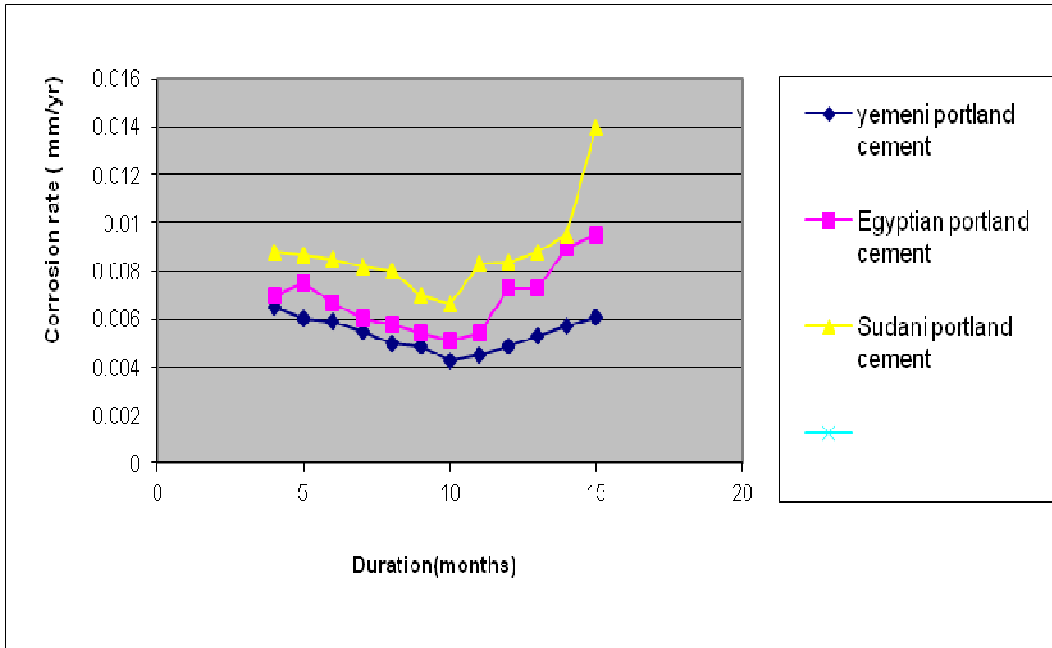

Fig. 3: ACI test results-TMT with Silica fume

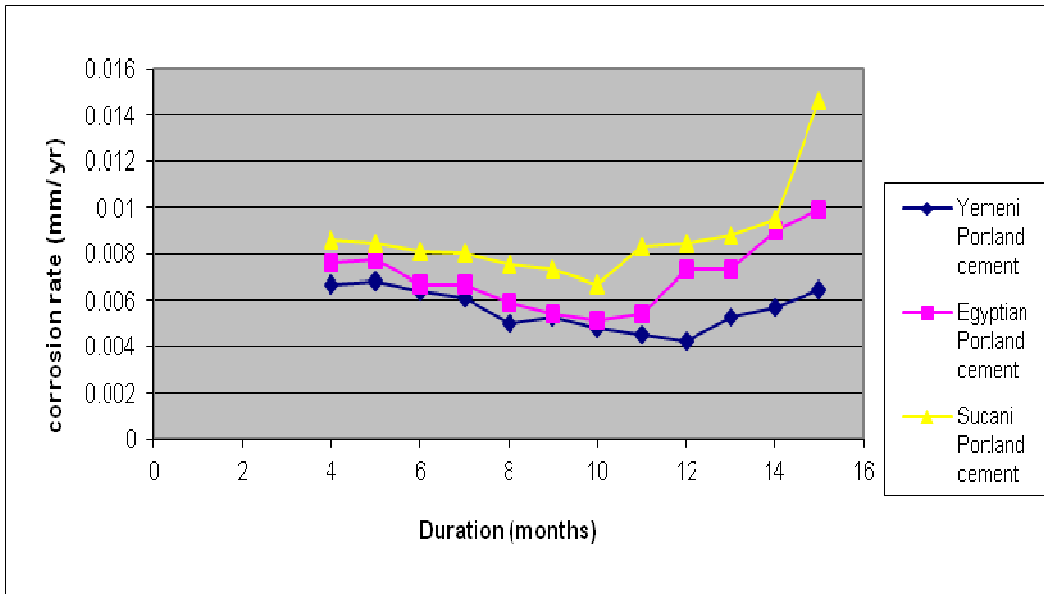

Fig. 4: ACI test results-TMT with fly ash

3.2 Weight Loss Measurements

Figures 5, 6 and 7 shows that the protective activity of passive film was destroyed after the 8th month for the two types of admixtures with 3%percentage added concrete, and even for the concrete without admixtures . The corrosion rate of TMT rod added with the Silica fume admixture of 3 % only showed less, when compared to

concrete with fly ash and the concrete without admixtures all the times. At the 15th month, rod embedded in control concrete took the lead and rate of corrosion is more than that of all the types of admixtures.

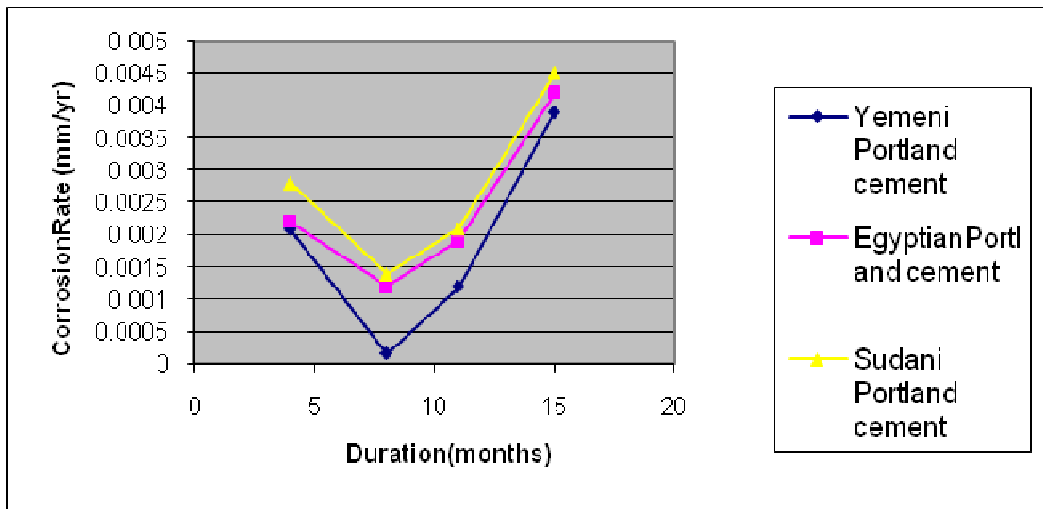

Fig.5: weight loss measurements - TMT bar without admixtures

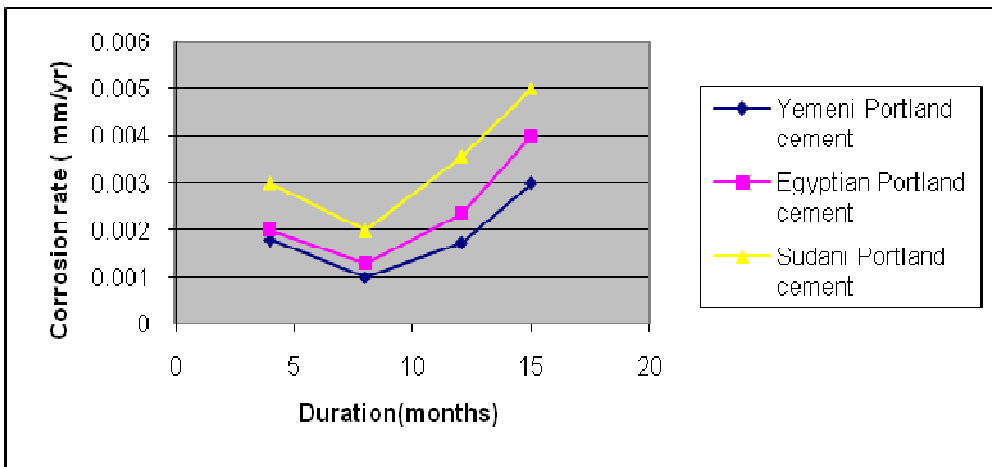

Fig.6: weight loss measurements- TMT bar with silica fume

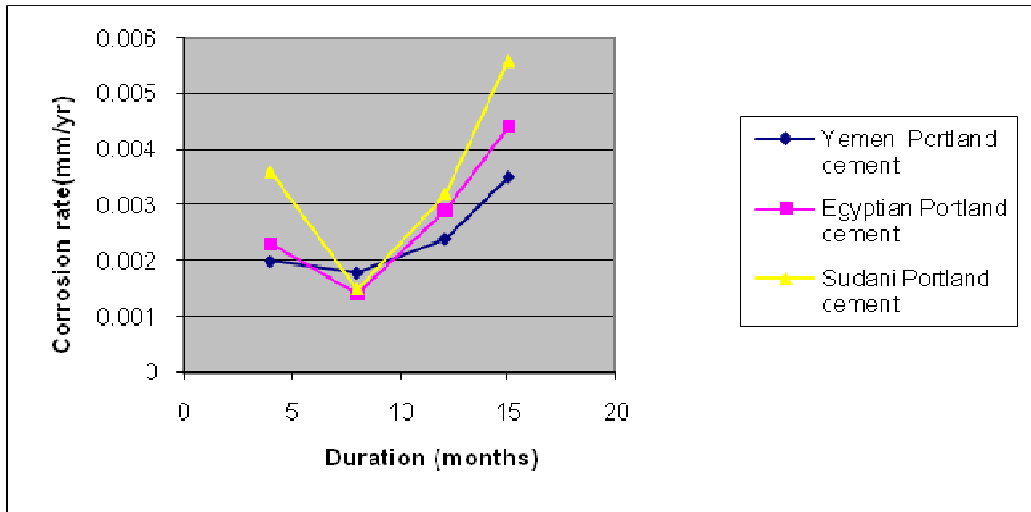

Fig.7: weight loss measurements- TMT bar with fly ash

4. CONCLUSIONS

Based on the experimental study, the following conclusions are made:

- 1- Initiation of corrosion in rebars was delayed due to the addition of mineral admixtures. Because of the continuous formation of passive film over the metal due to the chemical reactions took place with the metal surface and the admixtures added to concrete environment, the corrosion effect was reduced up to 8th or 11th month of casting and curing of cubes.
- 2- According to the results obtained from ACI measurement test, rods in concrete added with 3 % - water reducing admixtures gave better corrosion resistive character.
- 3- The destructive test of weight loss measurements exposed, the rods embedded with 3 % of water reducing mineral admixtures were always better in all the times and cases to resist corrosion ,in addition to silica fume was found better than fly ash.
- 4- From the overall data collected, it may be concluded that TMT rod embedded with concrete admixed with 3 % of water reducing mineral admixtures are better against the corrosion effect, than the concrete without admixtures.

REFERENCES

- [1] S. Baskar, J. Prabakar, P. Srinivasan. 2006. A. Chellappan. The Indian concrete journal. pp. 19-23.
- [2] X. Fu, D.D.L chung. 1997. Cement and Concrete Research 27. 1811-1815
- [3] Mars G. Fontanna. 2005. Corrosion Engineering. Third Edition, Tata Mc Graw-Hill Edition.
- [4] Luer Bertolini *et al.* 2004. Corrosion of steel in concrete (prevention, Diagnosis, Repair). WILEYVCH verlag GmbH HRCO. KGaA.
- [5] Jiangynan Hon, D.D.L. Chung. 2000. Corrosion Science 42. 1489-1507

- [6] DDL. Chung. 2000. Journal of Materials Engineering and Performance. 9(5): 585-588.
- [7] ML Gambhir. 1995. Concrete Technology. 2nd Edition, Tata Mc Graw-Hill Publishing Company Ltd., New Delhi.
- [8] Ha-won Song, Velu Saraswath. 2007. Int. J. Electrochem. Sci. 2: 1-28.
- [9] Ibrahim Turkmen, Mehmet Gavghah. 2003. Material Letters. 57: 3222-3233.
- [10] S.E. Benjamin, F.F. Khalid, Rizwan A. Khan. 2000. Journal of Materials Processing Technology. 103: 383-388.
- [11] F. Wombacher, U.marder, B.Marazzani. 2004. Cement and Concrete Composites. 26: 209-216.
- [12] Charles K.Nmai. 2004. Cement and Concrete Composites. 26: 199-207.
- [13] JMR. Dotto, A.G.de Abreu, D.C.C. Dal Molin, I.L. Mulle. 2004. Cement and Concrete Composites. 26: 31-39.
- [14] Scott A civjan, Jarmes F. La Fave, Joanna Trybulski, Daniel Lovett, Jose Lima. 2005. Donald W.P feifer, Cement and Concrete Composites. 27: 688-703.
- [15] Ha-won song, Velu saraswathy. 2006. Journal of Hazardous Materials. B 138: 226-233.
- [16] V. Saraswathy, Ha-won Song. 2007. Building and Environment. 42: 464-472.
- [17] Tae-Hyun Ha, Srinivasan Mualidharan, Jeong-Hyo Bae, yoon-cheol Ha, Hyun-Goo Lee, kyung-wha Park, Dae-kylong kin. 2007. Building and Environment. 42: 78-85.
- [18] ASTM G1-03. A1 Chemical cleaning procedures. p. 5.
- [19] ASTM G109-07. Standard Test Method for Determining Effects of Chemical Admixtures on Corrosion of Embedded Steel Reinforcement in Concrete Exposed to Chloride Environments.
- [20] ASTM, C 876. Standard Test Method for Half cell potentials of Uneoated Reniforceing steel in concrete. pp. 1-6.
- [21] ASTM C 494 / C 494 m-05. Standard specification for chemical Admixtures for concrete. pp. 1-10.
- [22] R. Vedalakshmi, K. Rajagopal, N. Panlaniswamy. 2008. Construction and Building Materials. 22: 186- 199.
- [23] G.De.Shutter, L. Lue. 2004. Construction and Building Materials. 18: 483-489.
- [24] Linhua jiang, Zhenquins Liu, Yiqun Ye. 2004. Cement and Concrete Research. 34: 1467-1469.

تأثير المضافات المعدنية علي مقاومة التآكل لقضبان حديد التسليح المستخدم في الخرسانة

المضافات المعدنية كثيرة الاستخدام للخرسانة ذات نسبة قليلة من الماء والاسمنت وذلك لتحسين التشغيلية للخرسانة وخصائصها الفيزيائية والميكانيكية . لوحظ ان معدل التآكل لحديد التسليح قد قل باستخدام هذه المضافات للحديد اللين المستخدم في الخرسانة وقد تم معالجتها ميكانيكا وحراريا. وقد بلغت النسبة المئوية للخلطات 3% وتمت الدراسة لمدة 15 شهرا ، تمت فيها دراسة الكروكيميائية باستخدام وفقدان الوزن . وكانت النتائج الملاحظة لكل المراحل الزمنية تناقص معدل التآكل والصدأ لكل 3% من المضافات المعدنية .