

OPTIMAL SHIFTING OF EIGENVALUES FOR LOAD FREQUENCY CONTROL SYSTEMS

Ali M. Yousef

Department of Electrical Eng., Faculty of Engineering, Assiut University, Assiut, Egypt

Received 15 June 2013; accepted 21 July 2013

ABSTRACT

This paper presents the robust optimal shifting of eigen values control design and application for load frequency control. A method for shifting the real parts of the open-loop poles to any desired positions while preserving the imaginary parts is constant. In each step of this approach, it is required to solve a first-order or a second-order linear matrix Lyapunov equation for shifting one real pole or two complex conjugate poles respectively. This presented method yields a solution, which is optimal with respect to a quadratic performance index. Load-frequency control (LFC) of a single and two area power systems is evaluated. The objective is to minimize transient deviation in frequency and tie-line power control and to achieve zero steady-state errors in these quantities. The attractive feature of this method is that it enables solutions to complex problem to be easily found without solving any non-linear algebraic Riccati equation. The control law depends on finding the feedback gain matrix and then the control signal is synthesized by multiplying the state variables of the power system with determined gain matrix. The gain matrix is calculated one time only and it works over wide range of operating conditions. To validate the powerful of the proposed optimal pole shifting control, a linearized model of a single and two interconnected area load frequency control is simulated.

Keywords: Optimal pole shifting controller; Load frequency control; Pole placement control.

1. Introduction

Design a feedback freedom may be used to achieve additional advantageous control properties. One of such desirable properties for feedback is the optimally for a quadratic performance index. Robustness properties of this optimal feedback gain have been presented. A problem has been considered for converted into reduced-order linear problems. In each of these problems, a first-order or a second-order linear Lyapunov equation is to be solved for shifting one real pole or two complex conjugate poles, respectively [1]. Power system oscillation is usually in the range between 0.1 Hz to 2 Hz. Improved dynamic, stability of power system can be achieved through utilization of supplementary excitation control signal [3. M.K. El-Sherbiny, G. El-Saady, A.M. Yousef, Robust controller for power system stabilization, MEPCON 2001, Helwan University, Cairo, Egypt, 29–31 December 2001, pp. 287–291.2,3]. The method is based on the mirror-image property. The problem of designing a feedback gain that shifts the poles of a given linear multivariable system to specified position has been studied extensively in the past decade [4 ,5]. Many control strategies have been proposed based on classical linear control theory. However, because of the inherent characteristics of the change loads, the operating point of a power system may change often during a daily cycle. The dynamic performance of power systems are usually affected by the influence of its control system [6-8]. It has been recognized that the complexity of a large electric power system has an adverse effect

Corresponding author.

E-mail address: drali_yousef@yahoo.com

on the systems dynamic and transient stability, and its stability can be enhanced by using optimal pole shifting control. Further, the two area power system, composed of steam turbines controlled by integral control only, is sufficient for all load disturbances, and it does not work well. Also, the non-linear effect due to governor deadzones and generation rate constraint (GRC) complicates the control system design. Further, if the two area power system contains hydro and steam turbines, the design of LFC systems is important. There are different control strategies that have been applied, depending on linear or non-linear control methods [9-10].

In this paper a comparison between pole placement control and proposed optimal pole shifting controller is presented in single and two-area load frequency control.

No Eigenvalues should have a multiplicity greater than the number of inputs. Calculate the feedback gain matrix K such that the single and two input system

$$\dot{X} = AX + BU \quad (1)$$

The feedback control law:

$$U = -K_{fb}X \quad (2)$$

Applied to Eqn.(1) a closed-loop system will be obtained in the form

$$\dot{X} = A_c X$$

$$\text{With } A_c = A - BK_{fb} \quad (3)$$

Consider $S_i = R_e(s_i) + j \text{Im}(s_i)$ to be a closed-loop pole of Eqn.(3). and $\lambda_i = R_e(\lambda_i) + j \text{Im}(\lambda_i)$ is open-loop poles of Eqn. (1) for any S_i and λ_i , which satisfy the optimality condition of, α_i [1] can be given :

$$\alpha_i = \frac{-[R_e(s_i) + R_e(\lambda_i)]}{2} \quad (4)$$

Where α_i is a positive real constant scalar.

R is a positive definite symmetric matrix. Then, for the following matrix algebraic equation:

$$P = (A + \alpha I) + (A^T + \alpha I)P - PBR^{-1}B^T P + Q = 0 \quad (5)$$

There exists a positive semi-definite real symmetric solution P satisfying $R_e(S_i) \leq -\alpha$

Therefore, according to[1]:

$$(S_i + \alpha)^2 = (\lambda_i + \alpha)^2$$

With $I = 1, 2, \dots, n$ and $K_{fb} = R^{-1}B^T$. Further, the feedback control law

$$U = -K_{fb}X \quad \text{Minimizes the following quadratic performance index:}$$

$$\int_0^{\infty} (X^T Q X + U^T R U) dt$$

With $Q = 2\alpha P$

2. Load Frequency Control Models

2. 1. Single area model

The load-frequency control plays an important role in power system operation and control. It makes the generation unit supply sufficient and reliable electric power with good quality. Fig. 1 shows the block diagram of single area load frequency control. The model considered here can be written in state equations form as follows:

$$\Delta \dot{f} = -\frac{1}{T_p} \Delta f + \frac{K_p}{T_p} \Delta P_g - \frac{K_p}{T_p} \Delta P_d$$

$$\Delta \dot{P}_g = -\frac{1}{T_t} \Delta P_g + \frac{1}{T_t} \Delta X_g$$

$$\Delta \dot{X}_g = -\frac{1}{RT_g} \Delta f - \frac{1}{T_g} \Delta X_g - \frac{1}{T_g} \Delta E + \frac{1}{T_g} U$$

$$\Delta \dot{E} = K_i \Delta f$$

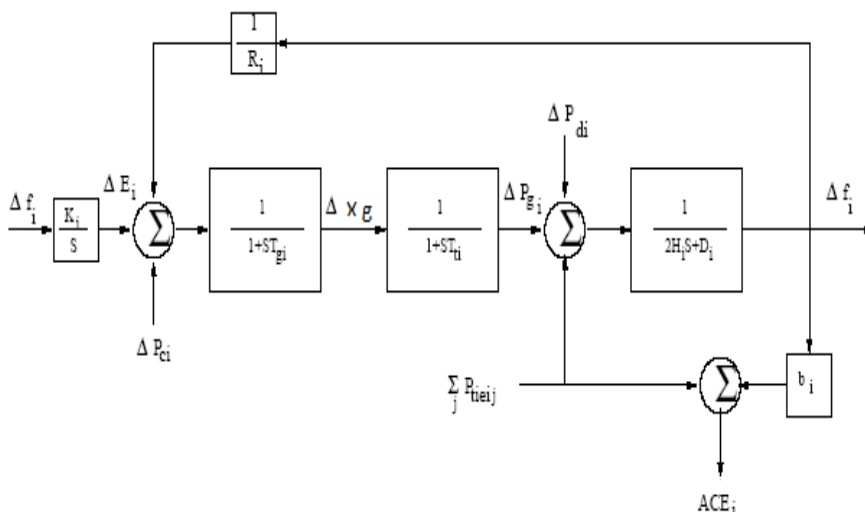

Fig. 1. Block diagram of single area load frequency control

2. 2. Two-Area Model

The system investigated comprises an interconnection of two areas load frequency control. The model is steam- hydraulic turbines. The linearized mathematical models of the first order system are represented by state variables equations as follows [4]:

For steam turbine area :

$$\Delta \dot{f}_1 = -1/T_{p1} \Delta f_1 + k_{p1} / T_{p1} \Delta P_{g1} - k_{p1} / T_{p1} \Delta P_{tie} - k_{p1} / T_{p1} \Delta P_{d1}$$

$$\Delta \dot{P}_{g1} = -1/T_{r1} \Delta P_{g1} + \Delta P_{r1} [1/T_{r1} - K_{r1} / T_{t1}] + K_{r1} / T_{t1} \Delta X_{E1}$$

$$\Delta \dot{P}_{r1} = 1/T_{t1} \Delta X_{E1} - 1/T_{t1} \Delta P_{r1}$$

$$\Delta \dot{X}_{E1} = -1/R_1 T_{g1} \Delta f_1 - 1/T_{g1} \Delta X_{E1} + 1/T_{g1} \Delta U_{p1}$$

For hydro turbine area:

$$\Delta \dot{f}_2 = -1/T_{p2} \Delta f_2 + k_{p2} / T_{p2} \Delta P_{g2} - k_{p2} / T_{p2} * a_{12} * \Delta P_{tie} - k_{p2} / T_{p2} \Delta P_{d2}$$

$$\Delta \dot{P}_{g2} = -\Delta P_{g2} [1/.5T_w + (1/.5T_2 - T_R / .5T_1 T_2)] + \Delta X_{E2} [1/.5T_w + 1/.5T_2] - T_R / .5T_1 T_2 R_2 \Delta f_2$$

$$\Delta \dot{X}_{E2} = -1/T_2 \Delta X_{E2} + \Delta P_{r2} [1/T_2 - T_R / T_1 T_2] + T_R / T_1 T_2 R_2 \Delta f_2$$

$$\Delta \dot{P}_{r2} = 1/T_1 \Delta P_{r2} - 1/R_2 T_1 \Delta f_2 + 1/T_1 \Delta U_{p1}$$

The tie line power as:

$$\Delta \dot{P}_{tie} = T_{12} [\Delta f_1 - \Delta f_2]$$

The overall system can be modeled as a multi-variable system in the form of

$$\dot{x} = Ax(t) + Bu(t) + Ld(t) \quad (6)$$

Where A is system matrix, B and L are the input and disturbance matrices.

$x(t)$, $u(t)$ and $d(t)$ are state, control and load changes disturbance vectors, respectively.

$$x(t) = [\Delta f_1 \quad \Delta P_{g1} \quad \Delta P_{r1} \quad \Delta X_{E1} \quad \Delta f_2 \quad \Delta P_{g2} \quad \Delta X_{E2} \quad \Delta P_{r2} \quad \Delta P_{tie}]^T \quad (7)$$

$$u(t) = [u_1 \quad u_2]^T \quad (8)$$

$$d(t) = [\Delta P_{d1} \quad \Delta P_{d2}]^T \quad (9)$$

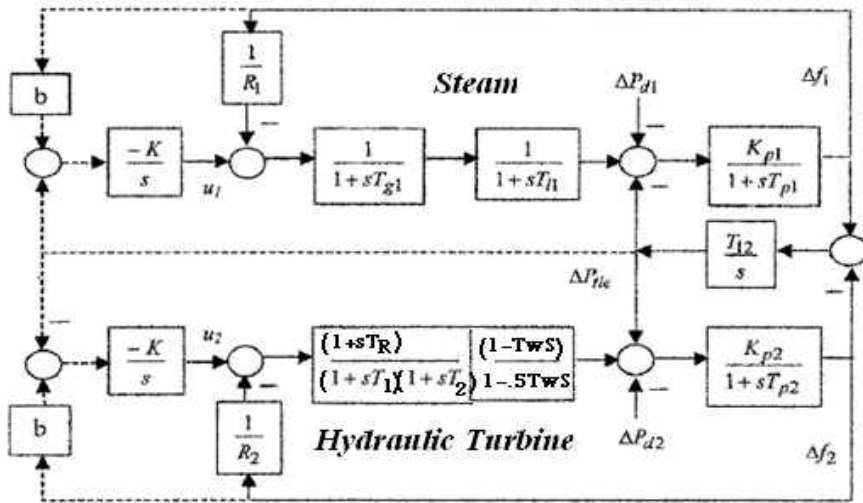

Fig. 2. Two-Area (*Steam-Hydraulic Turbines*) load frequency control

3. Optimal Pole Shifting Control

3.1. Shifting one real pole

A real pole $\lambda = \gamma$ is to be shifted to the new position $S = \sigma$ [3] which satisfies the optimality condition $|\sigma| > |\gamma_i|$. The first-order model to be used is defined by:

$$\Delta = \lambda \quad \text{and} \quad G = C^T B$$

Where C^T is the left eigenvector of A associated with λ , if the positive scalar α is:

$$\alpha = \frac{-(\sigma + \lambda)}{2} \tag{10}$$

Then an explicit solution for the above reduced-order problem can be obtained by solution of the first-order Lyapunov equation.

$$(\sigma + \alpha)\dot{V} + \dot{V}(\sigma + \alpha) = \dot{H} \tag{11}$$

Is given by $\dot{V} = \frac{\dot{H}}{2(\sigma + \alpha)}$ where:

$$\dot{H} = GR^{-1}G^T \tag{12}$$

Then the required parameters $\dot{P}, \dot{Q}, \dot{K}$ can be calculated as $\dot{K} = R^{-1}G^T \dot{P}$ $\dot{Q} = 2 \alpha \dot{P}$ and $\dot{P} = V^{-1}$ then, the parameter rewritten as:

$$\dot{P} = 2 \frac{(\sigma + \alpha)}{\dot{H}}, \quad \dot{Q} = \frac{4\alpha(\sigma + \alpha)}{\dot{H}} \quad \text{and} \quad \dot{K} = \left[\frac{2(\sigma + \alpha)}{\dot{H}} \right] R^{-1}G^T \tag{13}$$

3.2. Shifting a complex pole

A complex conjugate pair of poles λ , $\lambda = \gamma \pm j\beta$ of Eqn.(3) is to be shifted to the new positions S ; $S = \sigma \pm j\beta$, which satisfy the optimality condition: $|\sigma| > |\gamma_i|$.

Let positive scalar α as: $\alpha = \frac{-(\sigma + \lambda)}{2}$

The second- order model Λ to be used is defined as:

$$\Lambda = \begin{bmatrix} \gamma & -\beta \\ -\beta & \gamma \end{bmatrix} \quad G = C^T B \quad \text{and} \quad C^T = \begin{bmatrix} C_1^T \\ C_2^T \end{bmatrix} \quad (14)$$

Where $(C_1^T + jC_2^T)$ is the left eigenvector of Λ associated with the pole $\lambda = \gamma + j\beta$ and the left eigenvector satisfied the equation:

$$C^T \Lambda = \Lambda C^T \quad (15)$$

By solving the following second-order linear Lyapunov Equation of Eqn. (11)

$$(\Lambda + \alpha I)\dot{V} + \dot{V}(\Lambda^T + \alpha I) = \dot{H} \quad (16)$$

$$\dot{H} = GR^{-1}G^T$$

The parameters $\dot{P}, \dot{Q}, \dot{K}$ of the second-order optimal problem are obtained

$$\dot{K} = R^{-1}G^T \dot{P}, \quad \dot{Q} = 2 \alpha \dot{P} \quad \text{and} \quad \dot{P} = V^{-1} \quad (17)$$

Therefore, the feedback controller K_{fb} can be calculated from:

$$K_{fb} = \dot{K} C^T \quad (18)$$

Where:

$$P = C \dot{P} C^T \quad (19)$$

$$Q = 2 \alpha P \quad (20)$$

3.3. Shifting several poles

Problem of shifting several poles may be solved by the recursive applications of the following reduced order optimal shifting problem

$$\dot{Z}_i = \Lambda_i Z_i + G_i U_i \quad (21)$$

$$U = \dot{K}_i Z_i \quad (22)$$

$$\dot{J}_i = \int_0^\infty (Z_i^T \dot{Q}_i Z_i + U_i^T R U_i) dt \quad (23)$$

With :

$$C_i^T A_i = \Lambda_i C_i^T, \quad G_i = C_i^T B \quad (24)$$

And

$$A_{i+1} = A_i - BK_i$$

$$k_i = \dot{K}_i C_i^T \quad \text{and} \quad A_i = A \quad (25)$$

From Eqn. (18), the feedback matrix K can be constructed by the summation of the optimal feedback matrix K_i . Also the resulting matrices Q and P can be constructed as shown by the summation of the matrices Q_i and P_i , respectively.[1]

$$P = \sum_i P_i, \quad Q = \sum_i Q_i, \quad \text{and} \quad K_{fb} = \sum_i K_i \quad (26)$$

Where :

$$k_i = \dot{K}_i C_i^T, \quad P_i = C_i \dot{P}_i C_i^T, \quad \text{and} \quad Q_i = 2 \alpha_i P_i$$

4. Pole Placement Control

By using full-state feedback can shift the poles to the left hand side by (10-15)%. We could use the Matlab function `place` to find the control vector gain K , which will give the desired poles.

$$K = \text{place}(A, B, P) \quad (27)$$

Where:

- A: system matrix.
- B: input vector.
- P: pole shifting vector.
- K: control gain.

A state feedback matrix K such that the Eigenvalues of $A - B * K$ are those specified in vector P . The feedback law of $u = -kx$ has closed loop poles at the values specified in vector P .

$$\text{Poles} = \text{eig}(A - B * K)$$

5. Digital Simulation Results

5.1. Simulation of single area

The normal parameters of single area power system are:

$$T_g = 0.2 \text{Sec.}, T_t = 0.5 \text{Sec.}, \quad K_A = 1.25, T_A = 12.5 \text{Sec.}, 1/R = 20, \quad K_p = 2, T_p = 15 \text{Sec.}$$

The A and B matrices of single area model are calculated as:

$$A = \begin{bmatrix} -0.06 & 0.13 & 0 & 0 \\ 0 & -2.0 & 2.0 & 0 \\ -100 & 0 & -5 & -5 \\ 0.6 & 0 & 0 & 0 \end{bmatrix}$$

The dominant poles can be rewrite as:

$$-0.4752 \pm j2.1053 \\ -\xi \omega_n \pm j \omega_n \sqrt{1 - \xi^2}$$

Where;

ξ : damping coefficient

ω_n : Frequency

$$\begin{aligned} \xi \omega_n &= -0.478 & j \omega_n \sqrt{1 - \xi^2} &= j2.053 \\ \xi &= 0.22 & \omega_n &= 2.1 \end{aligned} \quad (28)$$

The settling time $T_s=72.7$ sec. the desired value of the damping coefficient can be choosing as $\zeta = 0.82$ to damping the oscillation of speed and constant imaginary part. The closed loop poles are specified as:

$$\zeta = 0.82 \text{ and } j \omega_n \sqrt{1 - \xi^2} = j2.05$$

From Eqn. (28) , calculate the $\omega_n = 3.568$ the new dominant eigenvalues can be calculated as follows

$$-\xi \omega_n \pm j \omega_n \sqrt{1 - \xi^2} = -2.92 \pm j2.053$$

The complete new poles are become as:

$$S_{1,2} = \sigma \pm j\beta = -2.92 \pm j2.053$$

$$S_3 = -6.08$$

$$S_4 = -0.0298$$

And calculate the settling time decreased (T_s) from 72.7 to 1 sec.

Shifting complex poles $\lambda_{1,2}$ to $S_{1,2}$, it can get:

$$\alpha_1 = -\frac{(-0.4752 - 2.92)}{2} = 1.7040$$

C_1^T : left eigenvector which satisfy the Eqn (14)

$$C_1^T = \begin{bmatrix} -7.27 & 0.23 & 0.195 & -0.35 \\ -11.07 & -0.64 & -0.198 & -0.55 \end{bmatrix}$$

$$\Lambda = \begin{bmatrix} -0.478 & 2.05 \\ -2.05 & -0.478 \end{bmatrix}$$

Form Eq. (14)

From Eqns. (15-16)

$$G_1 = \begin{bmatrix} 0.9706 \\ 1.4767 \end{bmatrix}$$

$$\dot{H}_1 = \begin{bmatrix} 0.94 & 1.433 \\ 1.433 & 2.18 \end{bmatrix}$$

Therefore, the solution of the corresponding second order Lyapunov equation is found

From Eqn. (16)

$$\dot{V} = \begin{bmatrix} 0.313 & 0.042 \\ 0.042 & 0.960 \end{bmatrix}$$

From Eq. (17)

$$\begin{aligned}\dot{P} &= \dot{V}_1^{-1} = \begin{bmatrix} 3.213 & -0.142 \\ -0.142 & 1.04 \end{bmatrix} \\ \dot{K}_1 &= R^{-1}G_1^T \dot{P}_1 = \begin{bmatrix} 2.908 & 1.409 \end{bmatrix} \\ \dot{Q}_1 &= 2 \alpha_1 \dot{P}_1 = \begin{bmatrix} 10.95 & -0.484 \\ -0.484 & 3.569 \end{bmatrix}\end{aligned}$$

From Eqns. (18-20), the feedback controller gain matrix can be calculated as:

$$\begin{aligned}K_1 &= \dot{K}C_1^T = \begin{bmatrix} -36.78 & -0.222 & 0.222 & -1.813 \end{bmatrix} \\ P_1 &= C_1 \dot{P}_1 C_1^T = \begin{bmatrix} 275.8500 & 1.6665 & -2.1656 & 13.6008 \\ 1.6665 & 1.6665 & -0.0013 & 0.0002 \\ -2.1656 & 0.3090 & 0.1749 & -0.1002 \\ 13.6008 & 0.0955 & -0.1002 & 0.6709 \end{bmatrix} \\ Q_1 &= 2 \alpha_1 P_1 = \begin{bmatrix} 940.09 & 5.6795 & -7.3805 & 46.3517 \\ 5.6795 & 2.2740 & 1.0531 & 0.3256 \\ -7.3805 & 1.0531 & 0.5959 & -0.3416 \\ 46.3517 & 0.3256 & -0.3416 & 2.2863 \end{bmatrix}\end{aligned}$$

Also, another shifting real pole from -0.0296 to -15

Calculate K2, P2 and Q2 as last.

$$K_2 = 1000 * \begin{bmatrix} -0.1123 & -0.0059 & -0.0032 & -1.4659 \end{bmatrix}$$

From Eqn. (26) the K total, P total and Q total are calculated as follows:

$K = K_1 + K_2$, $P = P_1 + P_2$, $Q = Q_1 + Q_2$ as follows:

$$\begin{aligned}P &= 1.0e+05 * \begin{bmatrix} 0.0112 & 0.0005 & 0.0002 & 0.1101 \\ 0.0005 & 0.0000 & 0.0000 & 0.0058 \\ 0.0002 & 0.0000 & 0.0000 & 0.0032 \\ 0.1101 & 0.0058 & 0.0032 & 1.4354 \end{bmatrix} \\ Q &= 1.0e+06 * \begin{bmatrix} 0.0136 & 0.0007 & 0.0004 & 0.1653 \\ 0.0007 & 0.0000 & 0.0000 & 0.0087 \\ 0.0004 & 0.0000 & 0.0000 & 0.0048 \\ 0.1653 & 0.0087 & 0.0048 & 2.1573 \end{bmatrix}\end{aligned}$$

The total control signal K is:

$$K_{optimal\ pole-shifting} = 1000 * \begin{bmatrix} -0.1491 & -0.0061 & -0.0030 & -1.4677 \end{bmatrix}$$

Pole placement Control Design

From Eqn.(27), desired vector P as: $P = [-7.0811, -0.6780 + 2.0534i, -0.6780 - 2.0534i, -2.296]$. The gain matrix $K = \text{place}(A, B, P)$

$$K_{pole\ placement} = \begin{bmatrix} -27.4982 & -1.1708 & -0.7619 & -95.9647 \end{bmatrix}$$

Figure 3 shows the frequency deviation response due to 10% load disturbance of single area with and without controller. Fig. 4 depicts the frequency deviation response due to 10% load disturbance of single area with pole-placement and proposed optimal pole-shifting control. Fig. 5 displays the root-locus of the system without control. Fig. 6 shows the root-locus of the system with optimal pole-shifting control. Fig. 7 depicts the frequency deviation response due to 10% load disturbance of single area with pole-placement and proposed optimal pole-shifting control at 50% increase in T_t and T_g . Also, Fig. 8 shows the

frequency deviation response due to 10% load disturbance of single area with pole-placement and proposed optimal pole-shifting control at 50% increase in T_p and K_p . Table 1 displays the eigenvalues calculation with and without controller. Table 2 depicts the settling time calculation at different load conditions.

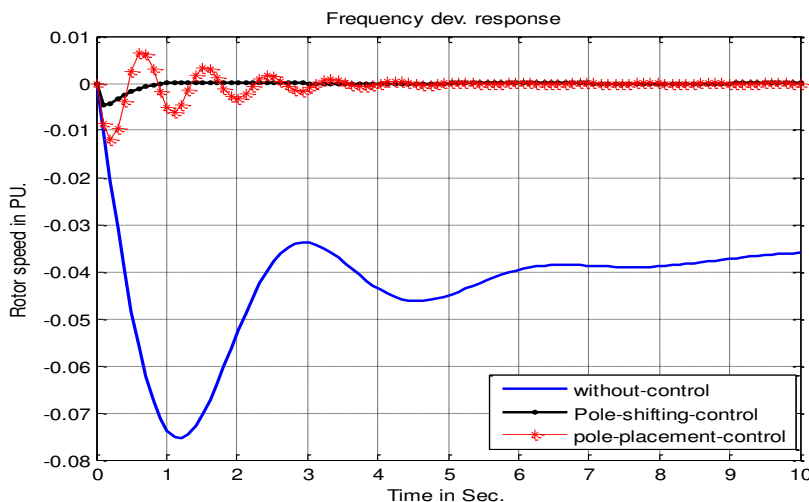

Fig. 3. Frequency deviation response due to 10% load disturbance of single area with and without controller.

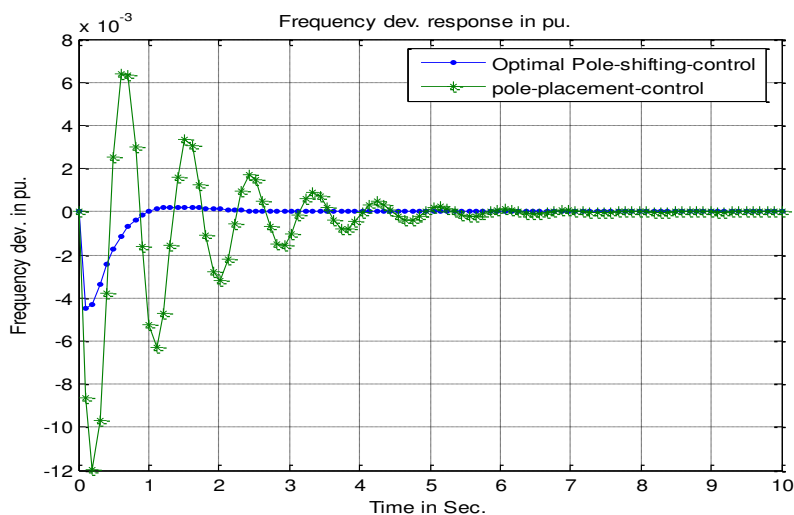

Fig. 4. Frequency deviation response due to 10% load disturbance of single area with pole-placement and proposed optimal pole-shifting control.

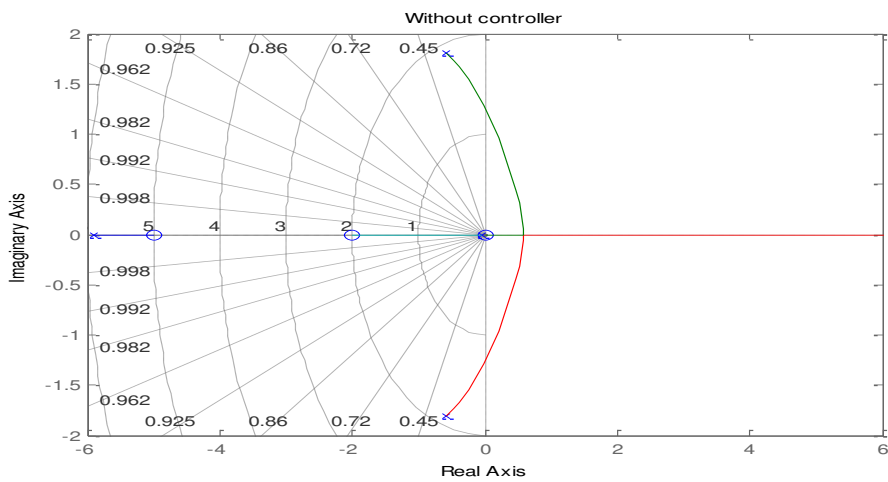

Fig. 5. Root-locus of the system without control

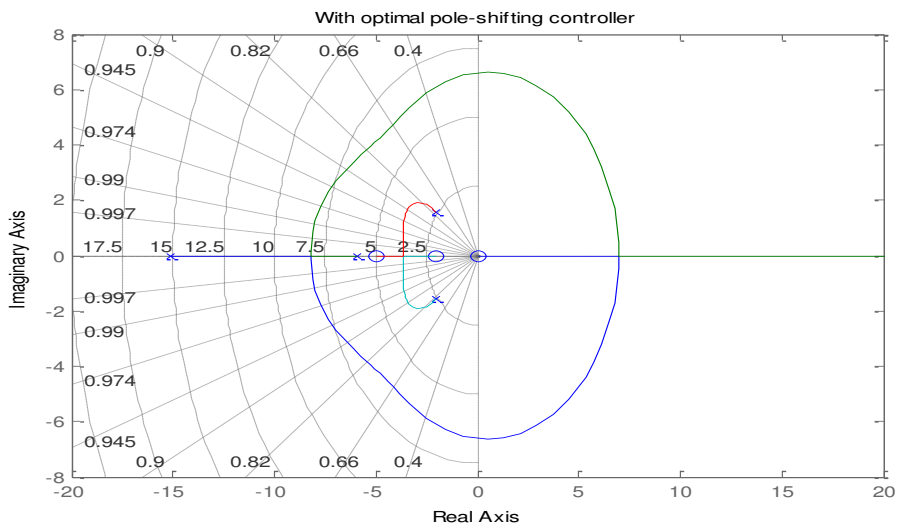

Fig. 6. Root-locus of the system with optimal pole-shifting control

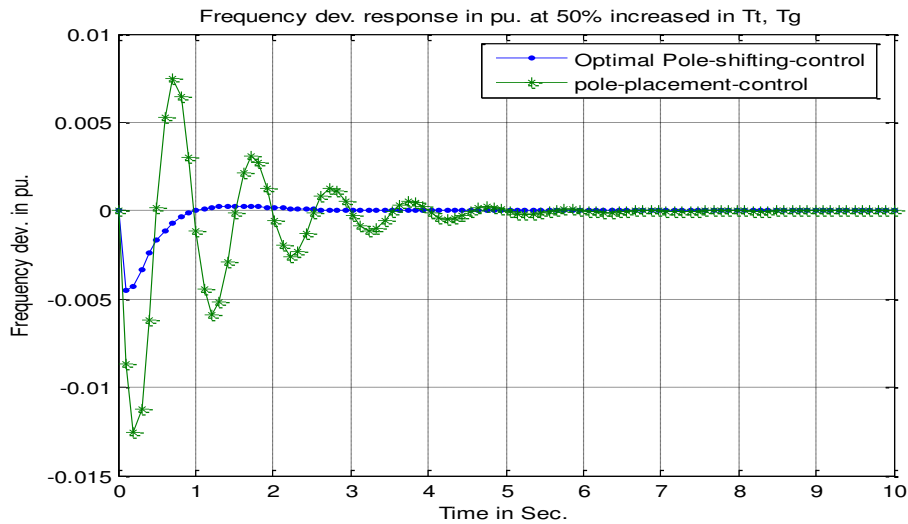

Fig. 7. Frequency deviation response due to 10% load disturbance of single area with pole-placement and proposed optimal pole-shifting control at 50% increase in T_t and T_g .

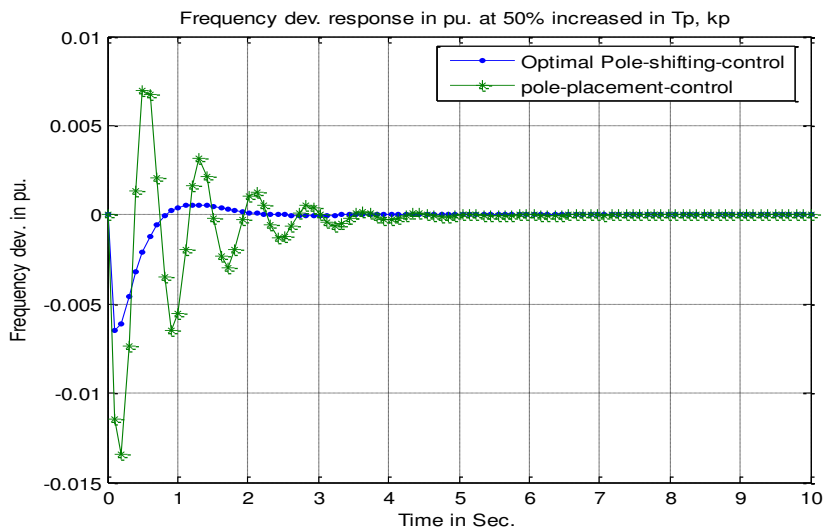

Fig. 8. Frequency deviation response due to 10% load disturbance of single area with pole-placement and proposed optimal pole-shifting control at 50% increase in T_p and K_p .

Table 1.

Eigenvalues calculation with and without controller.

Operating point	Without controller	Pole-placement controller	Optimal pole-shifting
Normal condition	-6.0811 -0.4780 + 2.0534i -0.4780 - 2.0534i -0.0296	-7.0811 -0.6780 + 2.0534i -0.6780 - 2.0534i -2.2960	-20.9998 -6.0811 -2.3821 + 1.8658i -2.3821 - 1.8658i
Increased 50% of Tt, Tg	-4.2808 -0.2115 + 1.6617i -0.2115 - 1.6617i -0.0296	-5.3678 -0.7661 + 1.9001i -0.7661 - 1.9001i -1.4996	-20.1695 -5.0664 -2.1407 + 0.7094i -2.1407 - 0.7094i
Increased 50% of Tp, kp	-6.1699 -0.4252 + 2.1711i -0.4252 - 2.1711i -0.0298	-7.3832 -0.7409 + 2.1134i -0.7409 - 2.1134i -2.3099	-23.4841 -5.9806 -2.4271 + 1.8637i -2.4271 - 1.8637i

Table 2.

Settling time calculation at different conditions.

	Case	Without Control	Pole-placement controller	Optimal pole-shifting
Settling Time	Normal condition	∞	7 Sec.	1.3 Sec.
	Increased 50% of Tt, Tg	∞	6 Sec.	2 Sec.
	Increased 50% of Tp, kp	∞	5 Sec.	2 Sec.

5. 2. Simulation of two-area model

To validate the effectiveness of the proposed optimal pole shifting controller, the power system under study is simulated and subjected to different parameters changes. The power system frequency deviations are obtained. Further a various types of turbines (steam, and hydro) are simulated. Also a comparison between the power system responses using the conventional pole-placement control and the proposed optimal pole shifting controller is studied as follows and the system parameters are:

Nominal parameters of the hydro-thermal system investigated [4],

$f=60$ HZ $R1=R2=2.4$ HZ/per unit MW

$Tg1=0.08$ s $Tr=10.0$ s $Tt=0.3$ s

$TR=10$ s $D1=D2=0.00833$ Mw/HZ

$T1=48.7$ s $T2=0.513$ s, $Tg2=0.08$ s

$Tt1=Tt2=0.3$ s $Kr1=Kr2=1/3$, $Pd1=0.05$ p.u.MW, $B1=B2=0.425$

$Pd2=0.0$, $Tr1=Tr2=20$ s, $T12=0.0707$ s, The integral control gain $Ki=1$ pu.

The A and B matrices of two- area model are calculated as:

$$A = \begin{bmatrix} -0.0500 & 6.0000 & 0 & 0 & 0 & 0 & 0 & 0 & -6.0000 \\ 0 & -0.1000 & -1.5667 & 1.6667 & 0 & 0 & 0 & 0 & 0 \\ 0 & 0 & -3.3333 & 3.3333 & 0 & 0 & 0 & 0 & 0 \\ -5.2083 & 0 & 0 & -12.5000 & 0 & 0 & 0 & 0 & 0 \\ 0 & 0 & 0 & 0 & -0.0500 & 6.0000 & 0 & 0 & 6.0000 \\ 0 & 0 & 0 & 0 & -0.1668 & -5.4984 & 5.8986 & 0 & 0 \\ 0 & 0 & 0 & 0 & 0.0834 & 0 & -1.9493 & 1.7492 & 0 \\ 0 & 0 & 0 & 0 & -0.0086 & 0 & 0 & -0.0205 & 0 \\ 0.5400 & 0 & 0 & 0 & -0.5400 & 0 & 0 & 0 & 0 \end{bmatrix},$$

$$B = \begin{bmatrix} -6 & 0 \\ 0 & 0 \\ 0 & 0 \\ 0 & 0 \\ 0 & -6 \\ 0 & 0 \\ 0 & 0 \\ 0 & 0 \\ 0 & 0 \end{bmatrix}$$

Choosing $\zeta = 0.82$ to damping the oscillation of speed and keep constant imaginary part. The closed loop poles are specified as:

$$\zeta = 0.82 \text{ and } j\omega_n\sqrt{1-\zeta^2} = j2.7673$$

From Eqn. (28), calculate the $\zeta\omega_n = 3.568$

The new dominant eigenvalues can be calculated as follows

$$-\zeta\omega_n \pm j\omega_n\sqrt{1-\zeta^2} = -3.568 \pm j2.767$$

$$\alpha_1 = -\frac{(-0.25 - 3.568)}{2} = 1.878$$

$$\Lambda = \begin{bmatrix} -0.257 & 2.767 \\ -2.767 & -0.257 \end{bmatrix}$$

From Eqn. 18, the control signal calculated as follows:

$$K1 = \begin{bmatrix} -0.5304 & 0.5748 & -0.4447 & -0.0179 & 0.3254 & 0.1813 & -0.3899 & -0.3712 & -1.1782 \\ 0.8987 & -0.9871 & 0.7571 & 0.0294 & -0.5506 & -0.3046 & 0.6683 & 0.6279 & 2.0182 \end{bmatrix}$$

Second complex pole $(-2.0048 + 0.1867i)$ shifted to $(-3.0048 + 0.1867i)$, the control signal gain K2 can be calculated as in Eqn. 18 as follows:

$$K2 = \begin{bmatrix} 0.1765 & -3.7233 & 1.9848 & 0.0338 & 0.1275 & 0.1391 & 0.5495 & -3.3969 & 0.0123 \\ -0.7047 & 15.3609 & -8.1609 & -0.1318 & -0.5098 & -0.5542 & -2.1648 & 13.8678 & -0.0311 \end{bmatrix}$$

Also, another shifting real pole from -0.0359 to 10

Control signal gain K3 is calculated as last.

$$K3 = 1000 * \begin{bmatrix} 0.0002 & 0.1340 & -0.0648 & 0.0006 & 0.0001 & 0.0001 & -0.0002 & -0.4154 & 0.0060 \\ -0.0005 & -0.3751 & 0.1815 & -0.0016 & -0.0004 & -0.0002 & 0.0007 & 1.1630 & -0.0167 \end{bmatrix}$$

From Eqn. (26) the K total, P total and Q total are calculated as follows:

$K = K_1 + K_2 + K_3$,
 $P = P_1 + P_2 + p_3$,
 $Q = Q_1 + Q_2 + Q_3$ as follows:
 The total control signal gain K from optimal pole-shifting controller is:

$$K = 1000 * \begin{bmatrix} 0.0002 & 0.1337 & -0.0647 & 0.0006 & 0.0002 & 0.0001 & -0.0002 & -0.4158 & 0.0059 \\ -0.0005 & -0.3736 & 0.1808 & -0.0016 & -0.0005 & -0.0003 & 0.0005 & 1.1644 & -0.0165 \end{bmatrix}$$

The pole-placement gain K_x as:

$$K_x = \begin{bmatrix} -0.2284 & -2.8613 & 1.2755 & -0.4932 & 0.2633 & -1.4968 & 4.3464 & -15.2923 & 0.6412 \\ -0.5369 & -43.7164 & 21.0860 & -0.0232 & -0.6402 & -3.8066 & 5.0404 & 186.2222 & -3.6676 \end{bmatrix}$$

Figure 9 shows the frequency deviation response of area-1 due to 5 % load disturbance with and without controller of two-area load frequency control model. Fig. 10 displays the frequency deviation response of area-2 due to 5 % load disturbance with and without controller of two-area load frequency control model. Fig. 11 depicts the frequency deviation response of area-1 due to 5 % load disturbance with and without controller at 50% increase in T_t and T_g of two-area load frequency control model. Fig. 12 shows the frequency deviation response of area-2 due to 5 % load disturbance with and without controller at 50% increase in T_t and T_g of two-area load frequency control model. Fig. 13 depicts the frequency deviation response of area-1 due to 5 % load disturbance with and without controller at 50% increase in T_p and K_p of two-area load frequency control model. Fig. 14 shows the frequency deviation response of area-2 due to 5 % load disturbance with and without controller at 50% increase in T_p and K_p of two-area load frequency control model. Table 3 displays the Eigenvalues calculation with and without controller of two-area model. Table 4 describes the Settling time calculation at different load conditions of two-area load frequency control model.

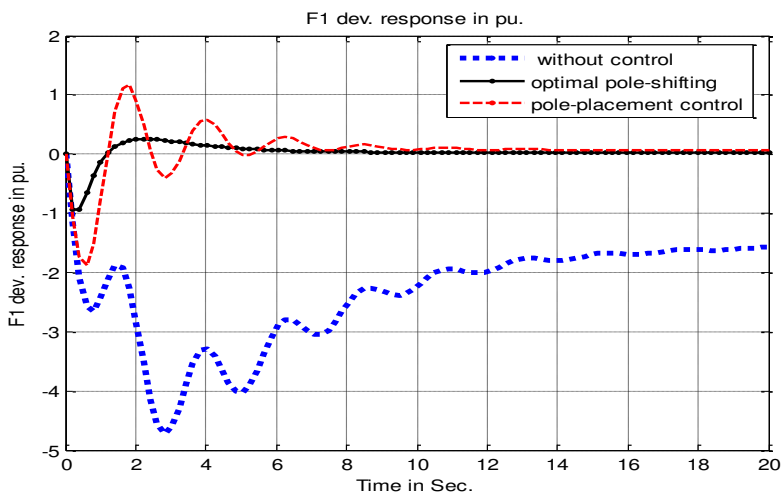

Fig. 9. Frequency dev. Response of area-1 due to 5 % load disturbance with and without controller of two-area load frequency control model.

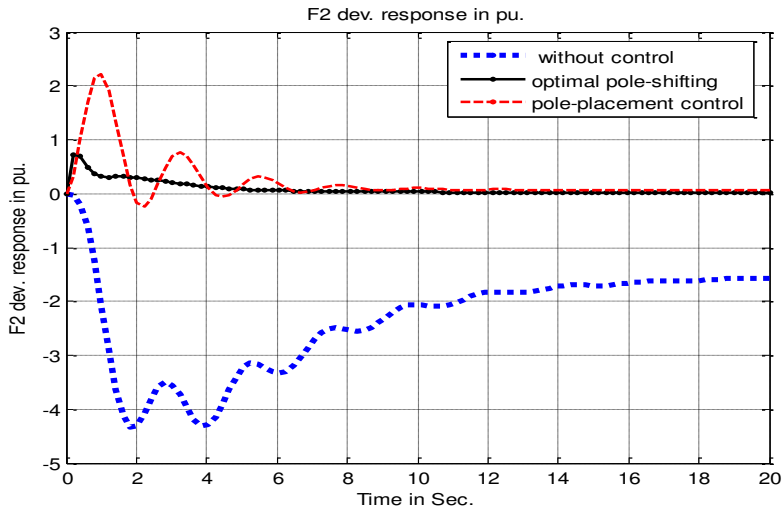

Fig. 10. Frequency dev. Response of area-2 due to 5 % load disturbance with and without controller of two-area load frequency control model.

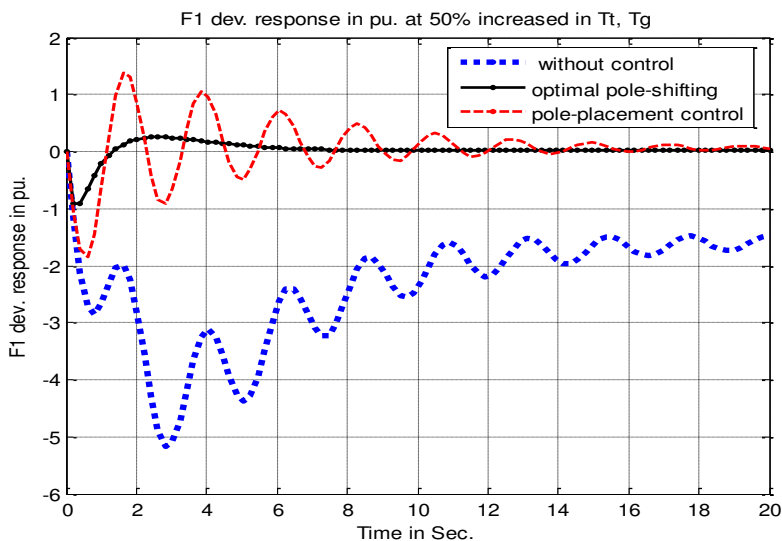

Fig. 11. Frequency dev. Response of area-1 due to 5 % load disturbance with and without controller at 50% increase in T_t and T_g of two-area load frequency control model.

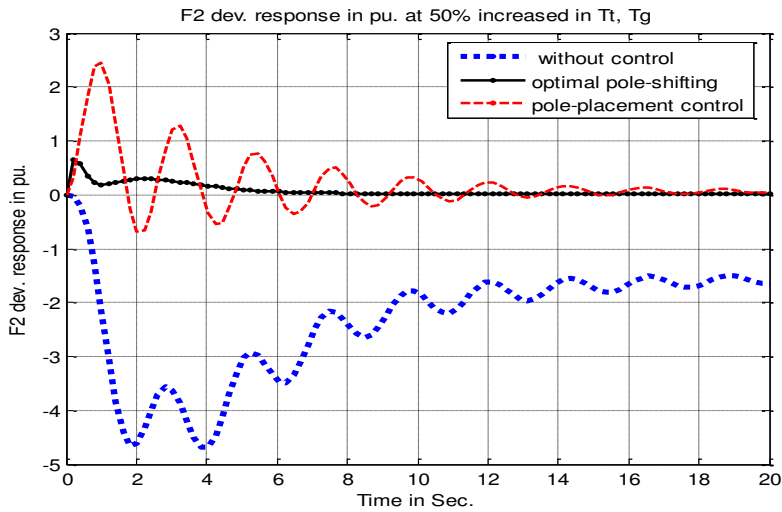

Fig. 12. Frequency dev. Response of area-2 due to 5 % load disturbance with and without controller at 50% increase in T_t and T_g of two-area load frequency control model.

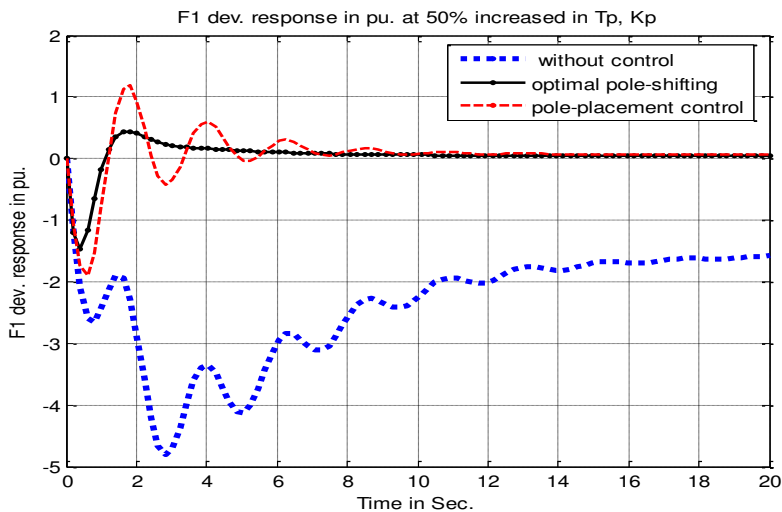

Fig. 13. Frequency dev. Response of area-1 due to 5 % load disturbance with and without controller at 50% increase in T_p and K_p of two-area load frequency control model.

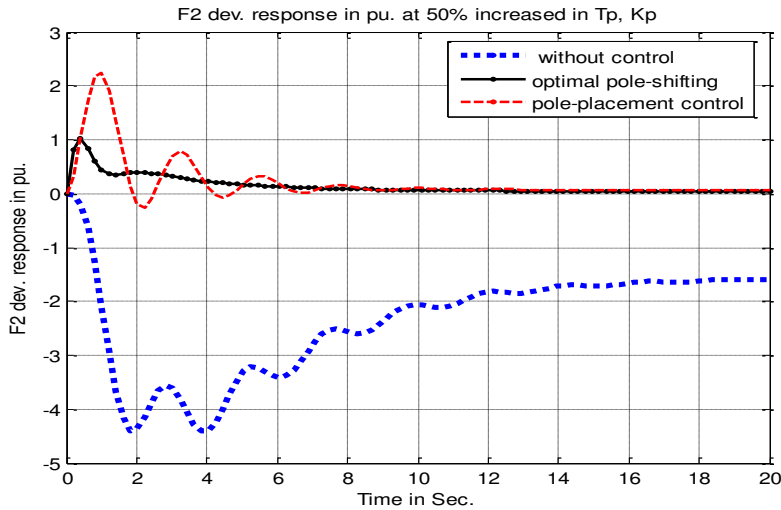

Fig. 14. Frequency dev. Response of area-2 due to 5 % load disturbance with and without controller at 50% increase in T_p and K_p of two-area load frequency control model.

Table 3.

Eigenvalues calculation with and without controller of two-area model.

Operating point	Without controller	Pole-placement controller	Optimal pole-shifting
Normal condition	-12.9116	-14.0001	-21.5740
	-5.1552	-7.1552	-10.5404
	-0.2571 + 2.7673i	-0.4571 + 2.7675i	-5.0341 + 1.1554i
	-0.2571 - 2.7673i	-0.4571 - 2.7675i	-5.0341 - 1.1554i
	-2.0048 + 0.1867i	-2.5048 + 0.1866i	-1.7651 + 2.1250i
	-2.0048 - 0.1867i	-2.5048 - 0.1866i	-1.7651 - 2.1250i
	-0.4375 + 0.0603i	-0.3590	-0.3938
	-0.4375 - 0.0603i	-0.6375 + 0.0604i	-2.0065
	-0.0359	-0.6375 - 0.0604i	-1.8743
Increased 50% of T_t , T_g	-8.7231	-9.7908	-24.5457
	-5.1547	-7.1388	-9.2482
	-0.1299 + 2.7517i	-0.2046 + 2.8483i	-0.6510 + 5.5860i
	-0.1299 - 2.7517i	-0.2046 - 2.8483i	-0.6510 - 5.5860i
	-2.2448	-2.3751 + 0.2174i	-5.2643
	-0.7321 + 0.3963i	-2.3751 - 0.2174i	-1.8383
	-0.7321 - 0.3963i	-0.3598 + 0.1749i	-1.6392
	-0.3412	-0.3598 - 0.1749i	-0.4360 + 0.2785i
	-0.0358	-0.6268	-0.4360 - 0.2785i
Increased 50% of T_p ,	-12.9111	-13.9984	-21.5307
	-5.1563	-7.1501	-10.5522

Operating point	Without controller	Pole-placement controller	Optimal pole-shifting
kp	-0.2477 + 2.7672i -0.2477 - 2.7672i -2.0111 + 0.1909i -2.0111 - 0.1909i -0.4236 + 0.1112i -0.4236 - 0.1112i -0.0361	-0.4441 + 2.7695i -0.4441 - 2.7695i -2.5038 + 0.1888i -2.5038 - 0.1888i -0.3570 -0.6392 + 0.0664i -0.6392 - 0.0664i	-5.0214 + 1.1508i -5.0214 - 1.1508i -1.7744 + 2.1179i -1.7744 - 2.1179i -0.3703 -2.0126 -1.8965

Table 4.

Settling time calculation at different conditions of two-area model.

	Case	Without Control	Pole-placement controller	Optimal pole-shifting
Settling Time	Normal condition	18 Sec. +SS	12 Sec.	6 Sec.
	Increased 50% of Tt, Tg	20 Sec. +SS	18 Sec.	6.3 Sec.
	Increased 50% of Tp, kp	18 Sec. +SS	14 Sec.	7 Sec.

6. Conclusions

The present paper introduces a new controller for damping quickly the power system frequencies and tie line power error oscillation and reducing their errors to zero. The problem of shifting the real parts of the open-loop poles to desired locations, while preserving the imaginary parts has been constant. Load-frequency control (LFC) of a single and two area power systems is evaluated. It has been shown that the shift can be achieved by an optimal feedback control law with respect to a quadratic performance index. However, this has been done without any solving non-linear algebraic Riccati equation. The merit of the presented approach is that it requires only the solution of a first-order or a second-order linear algebraic Lyapunov equation for shifting one real pole or two complex conjugate poles respectively. Moreover, the power system is subjected to different disturbances, and also, a comparison between the power system responses using the conventional pole-placement controller and the proposed optimal pole-shifting controller is presented and obtained. The digital simulation result shows the powerful of the proposed optimal pole shifting controller than conventional pole-placement controller in sense of fast damping oscillation and small settling time. Moreover, the optimal pole shifting controller has less overshoot and under shoot than pole-placement control.

7. References

- [1] M.K. El-Sherbiny, M. M. hasan, G. El-Saady and Ali M. Yousef, Optima pole shifting for power system stabilization. *Electric power system research journal* 66 (2003) , PP. 253-258.
- [2] M.H. Amin, Optimal pole shifting for continuous multivariable linear systems. *Int. J. Control* 41 3 (1985), pp. 701–707.

- [3] Nand Kishor, R. P. Saini and S. P. Singh , Optimal pole shift control in application to a hydro power plant. Journal of electrical engineering, Vol. 56, No. 11-12, 2005 PP. 290-297.
- [4] M.K. El-Sherbiny, G. El-Saady and Ali M. Yousef, Efficient fuzzy logic load-frequency controller. Energy Conversion & management journal 43 (2002) , PP. 1853-1863.
- [5] El-Saady G, El-Sadek MZ, Abo-El-Saud M. Fuzzy adaptive model reference approach-based power system static VAR stabilizer. Electric Power System Research, July, 1997.
- [6] J. Medanic , H. Tharp and W. Perkins "Pole placement by performance criterion modification", IEEE Trans. Auto. Cont., vol. 33, no. 5, pp.469 -472 1988.
- [7] N. Rousan and M. Sawan "Pole placement by linear quadratic modification for discrete time systems", Int. J. Systems Science, 1992.
- [8] P. Paul and M. Sawan "Pole placement by performance criterion modification", Proc. 32nd Midwest Symposium on Circuits and Systems, pp.128 -131 1989.
- [9] N. Kishor , S. P. Singh and A. S. Raghuvanshi "Dynamic simulation of hydro turbine and its state estimation based LQ control", Energy Convers. Manag., vol. 47, pp.3119 -3137 2006.
- [10] J. Herron and L. Wozniak "A state-space pressure and speed-sensing governor for hydro generators", IEEE Trans Energy Convers., vol. 6, no. 3, pp.414 -418 1991.

الإزاحة المثلى لأقطاب النظام للتحكم في تردد الحمل

الملخص العربي

تقدم هذه الورقة تصميم و تطبيق التحكم في تردد الحمل بالإزاحة العظمى للأقطاب لمنظومة كهربية، الطريقة تتمثل في إزاحة الأقطاب الحقيقية مع الاحتفاظ بالجزء التخيلي ثابت، خطوات هذه الطريقة تتمثل في حل معادلة لابنوف الخطية من الدرجة الأولى و الثانية لإزاحة قطب حقيقي أو قطب مركب من حقيقي و تخيلي على التوالي، هذا الحل المقدم في هذه الطريقة يركز على جدول الأداء التريبيعي، منظومة التحكم في تردد الحمل مكونة من محطة واحدة و محطتين تم تقييمهما، الهدف من هذه الطريقة هو الوصول إلى أقل اهتزازة في تردد الحمل و خط نقل القدرة الكهربية، الجاذب في هذه الطريقة هي إمكانية الحل في المشاكل المعقدة بطريقة سهلة و بسيطة بدون حل أي معادلة جبرية غير خطية، قانون التحكم يعتمد على إيجاد الكسب المرود و ضربه في متغيرات المنظومة لتحديد مصفوفة الكسب، مصفوفة الكسب تحسب مرة واحدة و تعمل عند نطاق تشغيل مختلفة، لبيان كفاءة و قدرة الطريقة المقترحة تم تمثيل منظومة كهربية مكونة من محطة واحدة و أيضاً محطتين.