



Using Bracing Systems to Improve the Seismic Performance of Moment Resisting Frame

Received 18 February 2022; Revised 24 May 2022; Accepted 24 May 2022

Yasser Abdel Shafy
Gamal¹

Keywords

Bracing models, Response spectrum, Retrofitting, MRF.

Abstract

Bracing systems [BS] have been widely adopted as the primary lateral load resisting system in medium and high-rise buildings due to their inherent substantial lateral stiffness and load resistance, and it is considered the most effective method for fusing existing RC structures. Therefore, the seismic response of steel braced frames [SBF] with bracing members connected to the columns had been explored for a moment-resisting frame [MRF]. And different configurations of BS had been investigated to study their effects on lateral load resistance and get the optimized bracing configurations. Moreover, the study doesn't take into consideration only the BS over the height of the building, but it also reduces the length of the bracing element by adding many bracing panels over the height of stories which can lead to an increase in the resistance of seismic loading. The bracing panels can be an effective technique in dealing with the architects' constraints. Therefore, smaller brace components can be chosen for studying to avoid the architect's constraints and create different configurations while still meeting code criteria for brace strength and overall slenderness. The earthquake behavior of the retrofitted structure was analyzed by distributing the SB of various types (X, V inverted) over the height of the RC frame. The results demonstrate that the smaller brace components for X & V inverted bracing can contribute to reducing the lateral displacement and maximum story drift.

1. Introduction

Structures intended to endure moderate and regular earthquakes are essential to be stiff and strong to limit displacement and prevent any potential damage. And it is ideal to design a structural system that combines stiffness and ductility in the utmost efficient way possible while keeping costs down. So, the designers are concerned with developing the structures' seismic behaviours in different manners. Two main retrofitting methods have been devised to improve the seismic performance of existing

¹ Yasser.gamal2310@mhiet.edu.eg, Lecturer, Dept. of Civil. Eng., El Minia High Technology Institute

construction buildings; the first is the addition of extra structural components, such as shear walls [SW] or steel braces [SB] and, the other is selective reinforcing of structural elements that are insufficient by means of concrete or steel jackets, as well as fibre-reinforced polymers [1], [2]. Traditional shear resisting materials such as concrete and masonry SW, or SB systems are an intriguing option due to their low cost and ease of construction. Therefore, SW or SB is commonly employed to raise the lateral load resistance of framed structures. Furthermore, there are numerous advantages to the usage of SB technique for RC frame seismic rehabilitation; including the capacity to accommodate openings, low added weight to the structure, and the capability to create external steel systems with minimal disturbance to the building's function and occupants [3].

The major technique to achieve the protection of structures against earthquakes is to renovate existing buildings to improve seismic performance. It can be achieved by numerous systems, such as adding SB with different patterns of concentricity and eccentricity. On the other hand, the diagonal bracing [DB] is naturally obstructive to the architectural layout. But it can cause issues with the management of interior space and traffic, as well as the place of window and door openings. Consequently, engineers usually focus on a V-inverted construction and BS with restricted height which provide an aperture in the middle of the story. Also, they are favored by architects over the concentrically braced system. So, the research's major purpose is to look at systems for improving the seismic behaviour of RC moment-resisting frames which can be accomplished by applying several types of bracing modelling (X, V inverted) over the RC frame height.

Unless some limits such as installing windows are considered, a bracing technique based on the whole structure is more appropriate [4]. In addition, a lot of studies have neglected the architectural constraints for the erection of the BS. Therefore, the study does not take into consideration only the BS over the height of the building, but it also reduces the length of the bracing element by adding many bracing panels over the height of stories which can lead to an increase in the resistance of seismic loading. The bracing panels can be an effective technique in dealing with the architects' constraints. Fig.3 shows the bracing panels for the cases of studies. Finite element programs are employed in modern structural design. Such programs are forceful and can be used to model structures in detail. However, it is well known that the correctness of FE-modelling outcomes is reliant on the inputs used to describe the model. In this research, ETABS 2018(CSI 2018) has been utilized to model and analyse all structures. And the essential metrics for comparing are lateral displacement [LD], story drift [SD], base shear[Q], and overturning moment [OM] in seismic analyses of RC frames.

2. Literature review

Existing reinforced concrete (RC) frame constructions with non-ductile details pose a significant risk during earthquakes. Therefore, most structural designers are still studying seismic retrofitting of structures taking into account the technical and economic aspects [5]. Moreover, by noticing the latest earthquakes which occurred in Mexico in 1985 and 1999 in Turkey the researchers have observed inadequate transverse reinforcement in beams, columns, and a lack of confinement of the column lap splice area. In addition, all the previous factors have been contributing to the brittle behaviour of RC frames which may be accountable for the utmost numbers of the fatalities [3]. On the other hand, adding SB to masonry infill RC buildings is a cost-effective technique and an effective tool for increasing the strength of soft story. In other words, the additional BS provides the soft story with the necessary rigidity [6]. It is obvious that X-DB hinders the vehicles and mobility, particularly in developing countries where the areas are limited, and the parking space on the first floor is the only

option [7]. As a result, in the midst of numerous types of bracing, several researchers have investigated the X-DB for strengthening weak or soft-story building [8], [9]. Since 1930, eccentric bracing has been utilized in steel constructions where in architectural purposes it has been used frequently since 1970. Following that, eccentric bracing has been examined and added to steel constructions as a structural element. In addition, this BS is favored over other bracing systems in steel constructions because of its high lateral stiffness, and sufficient ductility [10]. Many investigators have studied the application of concentric and eccentric bracing in concrete frames since 1981 [11], [3], [12], [5], [13], [14], [4] and [15].

Over the past three decades, several types of SB have been used to boost the seismic capabilities of RC frames and they have been converted into a major study. Also, the BS are categorized into two categories: exterior bracing and interior bracing. External bracing consists of SB system that is permanently linked to the side of the RC frame [RCF]. The drawbacks of BS are architectural problems and proper connections between SB and RC frame. The BS is positioned by an internal bracing technique within the separate bays of RCF. And it can be directly or indirectly connected to the frame system. Furthermore, in the case of indirect connection, the load transfer from SB to the concrete frame, is accomplished indirectly through the steel frame. Nevertheless, the direct connection between BS and RC frame has been created with a quantifier connection between them which led to less interference with RCF. And, this direct connection is easier and cheaper in comparison with the other type [16]. Abou-Elfath and Ghobarah looked at how low-rise RC frames have performed before and after they were upgraded with direct SB [17] and [3].

The seismic assessment in RC buildings retrofitted with SB frames has been studied by Vahedi, and his results have shown that premature shear and/or axial failures of RC columns are more likely to occur in non-retrofitted due to a lack of required ductility. In addition, it was discovered that the axial and shear forces in the boundary RC columns, as well as the SB slenderness ratios, are the key elements that determine the seismic reactions of structures retrofitted with SBF [18]. And, Kaveh demonstrated that the zipper bracing added to reinforced RC constructions improves performance and stiffness without the need to reinforce the beams and columns [19]. The DB is naturally obstructive to the architectural layout, causing issues with internal space and traffic management, as well as the position of openings. Therefore, the designers are concentrating on V-inverted structures which provide an aperture in the middle of the story. Therefore, they are favored by architects over the concentrically braced option.

3. Mathematical modelling

3.1. The numerical modelling of MRF:

Three structural models have been examined at different heights [four, eight, twelve stories]. And the moment-resisting frame models have been created from three bays with lengths of five meters. Also, the structural model height for each story is 3.6 m. A preliminary design approach was used to estimate the dimensions of the structural parts, where all structural elements have been designed according to ECP 2008 code. But the SSI has not been taken into consideration. The ground-floor column bases were presumed to be fixed, and all dimensions and detailed designs of cross-sections for columns and beams have been presented in Table 1, and the arrangements of reinforcement for columns have been exposed in Fig 1. Material properties [Concrete's compressive strength f_c , and tensile strength f_t] have been determined to be 28 MPa and 3.17 MPa, respectively. The yield stress for steel bars f_y is equal to 350 MPa, and modulus of elasticity E is equal to 200,000 MPa. The dead

load and live load were presumed to be thirty kN/m and 10 kN/m, respectively. And the design base shears for a Peak Ground Acceleration (PGA) for 5B Zone is 0.3 g. The weights of the frames have been determined as the dead load plus 25% of the live load for evaluating the equivalent static load method load based on the Egyptian [EGY] code.

Table 1: Dimensions and reinforcement of frame members

	Dimension (cm)	Longitudinal reinforcement	Transverse Reinforcement
Four Stories			
C1	60 * 60	18 Ø 16 mm	10 mm @ 180 mm c/c
B1	60 * 60	6 Ø 16 mm top 6 Ø 16 mm bottom	10 mm @ 150 mm c/c
Eight Stories			
C1	60 * 60	18 Ø 16 mm	10 mm @ 180 mm c/c
C2	60 * 60	18 Ø 18 mm	10 mm @ 180 mm c/c
B1	60 * 60	6 Ø 16 mm top 6 Ø 16 mm bottom	10 mm @ 150 mm c/c
Twelves stories			
C3	60 * 80	12 Ø 22 mm	10 mm @ 180 mm c/c
C4	60 * 80	14 Ø 22 mm	10 mm @ 180 mm c/c
C5	60 * 100	16 Ø 22 mm	10 mm @ 180 mm c/c
C6	60 * 100	16 Ø 22 mm	10 mm @ 180 mm c/c
C7	60 * 100	18 Ø 22 mm	10 mm @ 180 mm c/c
B1	60 * 60	6 Ø 16 mm top 6 Ø 16 mm bottom	10 mm @ 150 mm c/c

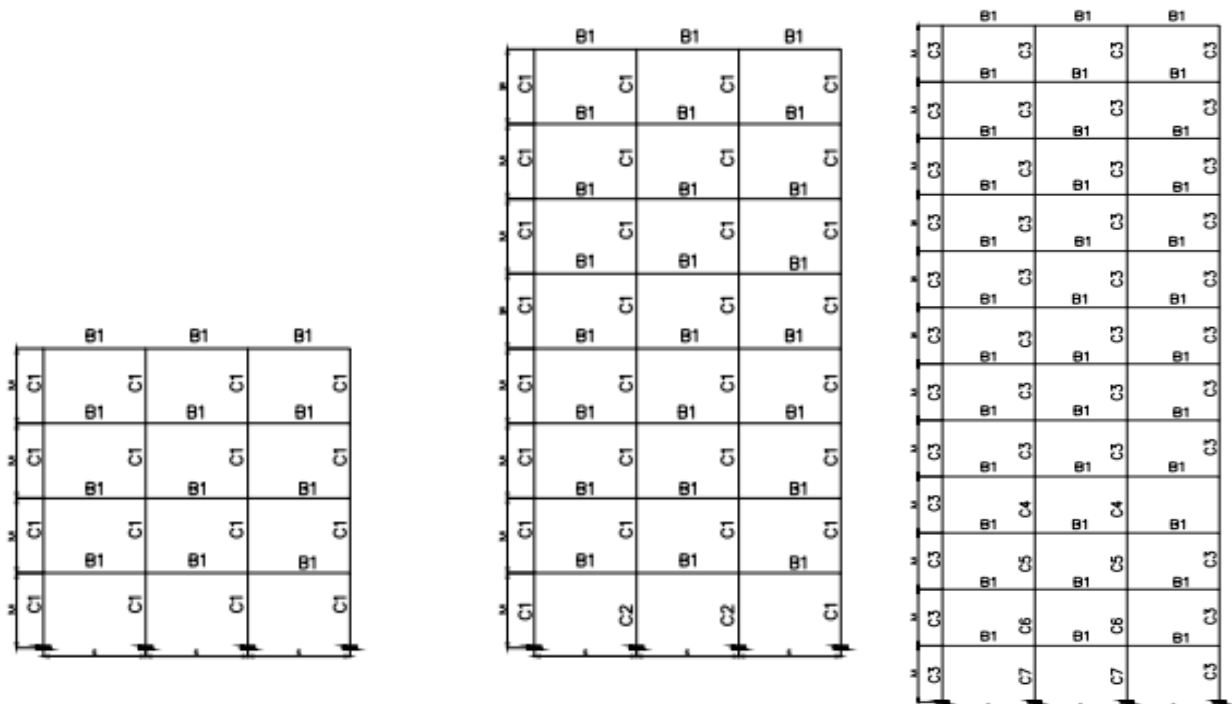

No of stories [Four, Eight, Twelve]

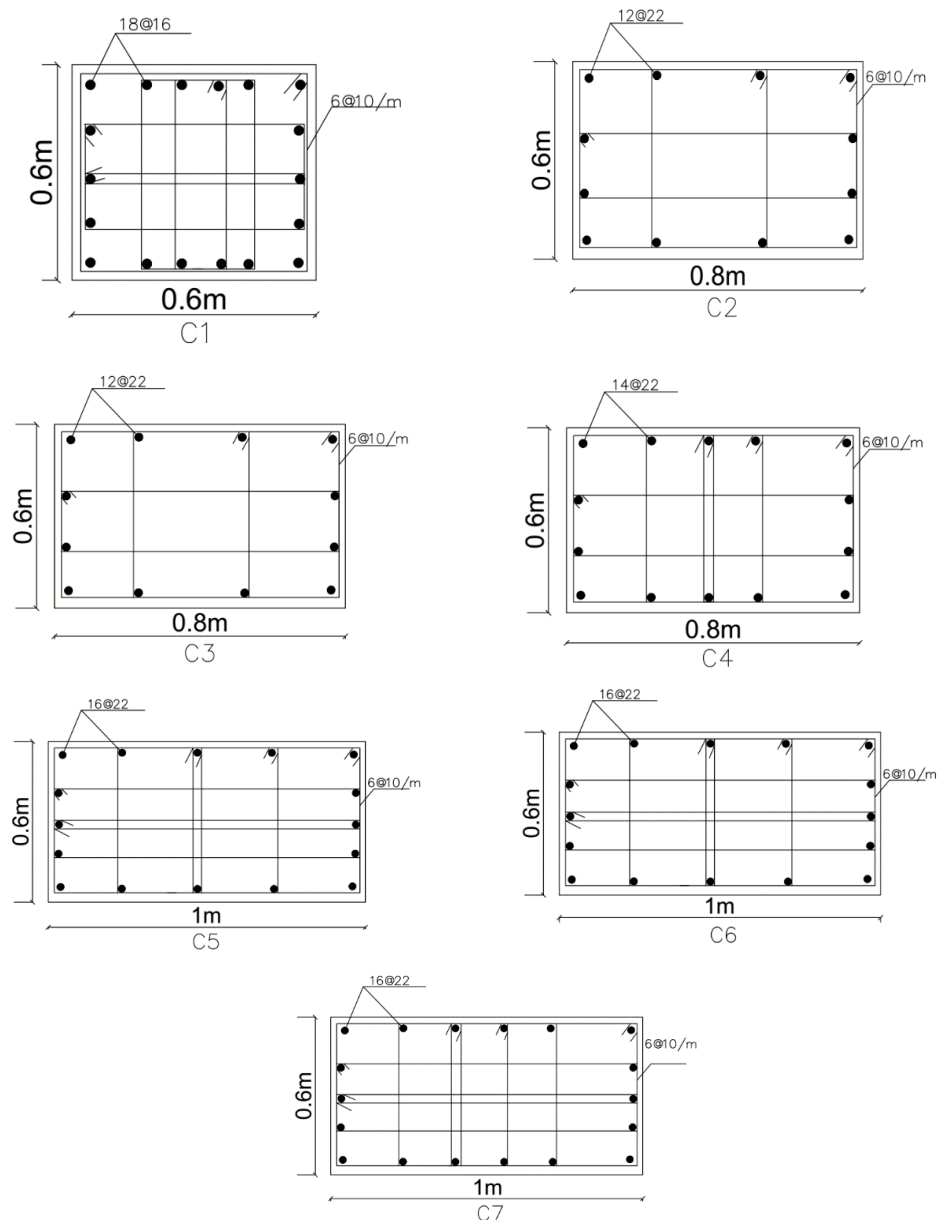

Fig.1 The arrangements of reinforcement for columns

3.2. The braced frame details

The X and inverted V steel brace systems have been used in the present study. And the effectiveness of different configurations which have been used such as bracing over the height of the story, bracing for only 1 m from the height of each story as well as the spatial distribution of X and inverted V steel bracing over the height of the building. They have been functioned to achieve the best performance with the least amount of steel. Four, eight, and twelve retrofitting MRF cases have been designed. Twenty-four retrofitting cases have been defined based on the configuration of the SB system. All models [Reference Model [RM], Retrofitting Model [RETM]] are reported in Table 2.

The goal of this research is to see how a bracing technique for retrofitting moment resisting frames [MRF] affects the seismic performance. X, and inverted V BS have been examined with different heights along the frame. The configuration of bracing modelling [BM] of four stories from Model R5 to R8 have been projected in Fig.3. Its configurations have been plotted for retrofitting of MRF to meet the requirements of architects. In addition, figures 3, 4, and 5 show different SB models.

The bracing members have sizes based on Eurocode 2005 and ANSI/AISC 341-10 code to carry the seismic forces. All the braces have been made from square HSS elements confirming to modulus of elasticity of steel $[E] = 200,000 \text{ MPa}$. And the steel yield strength $[f_y]$ is equal to 350 MPa . The X bracing and V inverted steel braces have been employed for strengthening and boosting the seismic performances. Furthermore, the bracing cross sections differ from one level to another as shown in Table.3; the cross sections of braces are HSS3-1/2*3-1/3*0.188 and HSS2-1/2*2-1/2*0.188 for four stories modelling. Whereas the HSS4-1/2*4-1/2*0.188 and HSS3-1/2*3-1/2*0.188 have been used in eight stories modelling, as well as HSS4-1/2*4-1/2*0.250, HSS4-1/2*4-1/2*0.188, and HSS3-1/2*3-1/2*0.188 have been employed in twelve stories modelling.

The brace slenderness ratio ranges from fifty to two hundred, where the lower limit applies for KL/r is equal to 50. And, the maximum limit of 200 have been based on the slenderness ratio limiting values of ANSI/AISC 341-10 [20] to exhibit a ductile behaviour. Furthermore, the width-to-thickness ratio of the brace cross section $[b_o/t \text{ ratio}]$ range between 11.4 and 22.8; where b_o is equal to $b-3t$ [the total width of the brace section minus three thickness of the brace section]. And the top limit of b_o / t ratio for this investigation is 22.8. The values C_f/C_r (compression load to resistance ratio) for brace sections are close to 1.0. A horizontal strut has been installed between the bracing panels to ensure direct lateral load transmission for bracing panel systems [(R5-R8), (R13-R16), (R21-R24)]. Fig.2 shows the specifics of a proposed linking among the bracing elements and the RC frame members. Where, steel plates had been attached to concrete columns and beams. Consequently, the forces can be transferred from BS to the frame elements directly. Moreover, the steel plates that surround the beams are anchored through the concrete section, where the column's steel plates are welded together. In addition, a gusset plate can be used to distribute the force from the brace member to both beam and column plates [17].

Table 2: Models of the structural systems

Code	Description of Model	Types of Models	Code	Description of Model	Types of Models
Four Stories			Eight Stories		
OR 4	without bracing [W-B]	RM	OR 8	[W-B]	RM
RET 1	[X bracing [X-B] in all bays]	RETF	RET 9	[X -B] in all bays]	RETF
RET 2	[Inverted V bracing [IV-B] in all bays]	RETF	RET 10	[IV-B] in all bays]	RETF
RET 3	[[X-B] in Mid bay]	RETF	RET 11	[X -B] in Mid bay]	RETF
RET 4	[[IV-B] in Mid bay]	RETF	RET 12	[[IV-B] in Mid bay]	RETF
RET 5	[1m height of [X-B] in all bays]	RETF	RET 13	[1m height of [X-B] in all bays]	RETF
RET 6	[1m height of [IV-B] in all bays]	RETF	RET 14	[1m height of [IV-B] in all bays]	RETF
RET 7	[1m height of [X-B] in Mid bay]	RETF	RET 15	[1m height of [X-B] in Mid bay]	RETF
RET 8	[1m height of [IV-B] in Mid bay]	RETF	RET 16	[1m height of [IV-B] in Mid bay]	RETF

Code	Description of Model	Types of Models	Code	Description of Model	Types of Models
Twelve stories					
OR 12	[W-B]	RM			
RET 17	[X bracing in all bays]	RETF	RET 21	[1m height of [X-B] in all bays]	RETF
RET 18	[IV – B] in all bays]	RETF	RET 22	[1m height of [IV-B] in all bays]	RETF
RET 19	[[X-B] in Mid bay]	RETF	RET 23	[1m height of [X-B] in Mid bay]	RETF
RET 20	[[IV-B]in Mid bay]	RETF	RET 24	[1m height of [IV-B] in Mid bay]	RETF

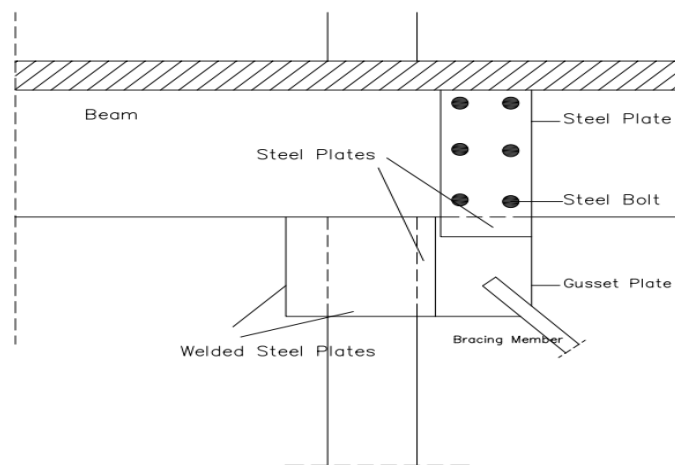
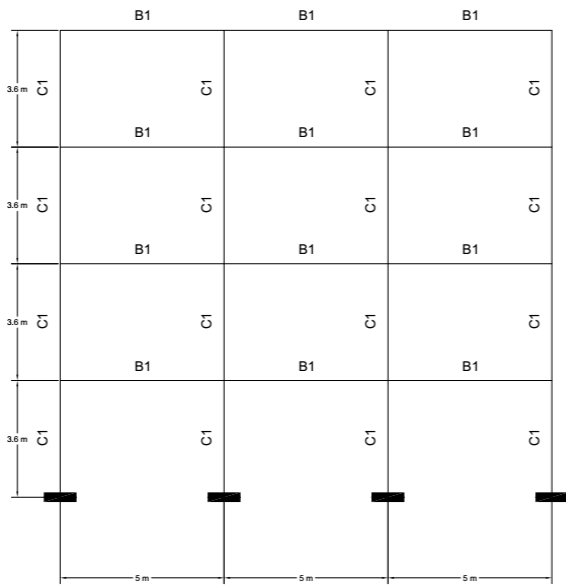

Fig. 2: The details of connection between the bracing member and RC Frame [17]

Table.3 Details of bracing cross section

Story Level	Bracing Cross section	Depth (m)	Width (m)	Flange thickness (m)	Web thickness (m)
Four stories					
Level 1	HSS3-1/2*3-1/2*0.188	0.0889	0.0889	0.00442	0.0042
Level 2	HSS3-1/2*3-1/2*0.188	0.0889	0.0889	0.00442	0.0042
Level 3	HSS3-1/2*3-1/2*0.188	0.0889	0.0889	0.00442	0.0042
Level 4	HSS2-1/2*2-1/2*0.188	0.0635	0.0635	0.00442	0.0042
Eight stories					
Level 1	HSS4-1/2*4-1/2*0.188	0.1143	0.1143	0.00442	0.0042
Level 2	HSS4-1/2*4-1/2*0.188	0.1143	0.1143	0.00442	0.0042
Level 3	HSS4-1/2*4-1/2*0.188	0.1143	0.1143	0.00442	0.0042
Level 4	HSS4-1/2*4-1/2*0.188	0.1143	0.1143	0.00442	0.0042
Level 5	HSS3-1/2*3-1/2*0.188	0.0889	0.0889	0.00442	0.0042
Level 6	HSS3-1/2*3-1/2*0.188	0.0889	0.0889	0.00442	0.0042
Level 7	HSS3-1/2*3-1/2*0.188	0.0889	0.0889	0.00442	0.0042
Level 8	HSS3-1/2*3-1/2*0.188	0.0889	0.0889	0.00442	0.0042

Story Level	Bracing Cross section	Depth (m)	Width (m)	Flange thickness (m)	Web thickness (m)
Twelve stories					
Level 1	HSS4-1/2*4-1/2*0.250	0.1143	0.1143	0.00592	0.00592
Level 2	HSS4-1/2*4-1/2*0.250	0.1143	0.1143	0.00592	0.00592
Level 3	HSS4-1/2*4-1/2*0.188	0.1143	0.1143	0.00442	0.0042
Level 4	HSS4-1/2*4-1/2*0.188	0.1143	0.1143	0.00442	0.0042
Level 5	HSS4-1/2*4-1/2*0.188	0.1143	0.1143	0.00442	0.0042
Level 6	HSS4-1/2*4-1/2*0.188	0.1143	0.1143	0.00442	0.0042
Level 7	HSS4-1/2*4-1/2*0.188	0.1143	0.1143	0.00442	0.0042
Level 8	HSS4-1/2*4-1/2*0.188	0.1143	0.1143	0.00442	0.0042
Level 9	HSS4-1/2*4-1/2*0.188	0.1143	0.1143	0.00442	0.0042
Level 10	HSS4-1/2*4-1/2*0.188	0.1143	0.1143	0.00442	0.0042
Level 11	HSS3-1/2*3-1/2*0.188	0.0889	0.0381	0.00442	0.0042
Level 12	HSS3-1/2*3-1/2*0.188	0.0889	0.0381	0.00442	0.0042



OR4

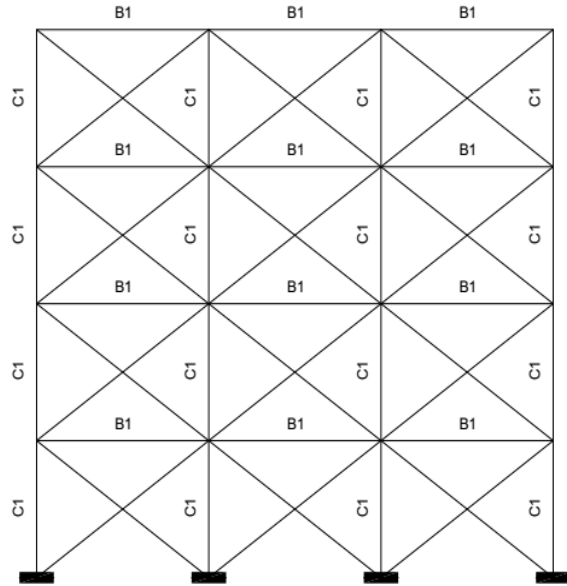

RET 1

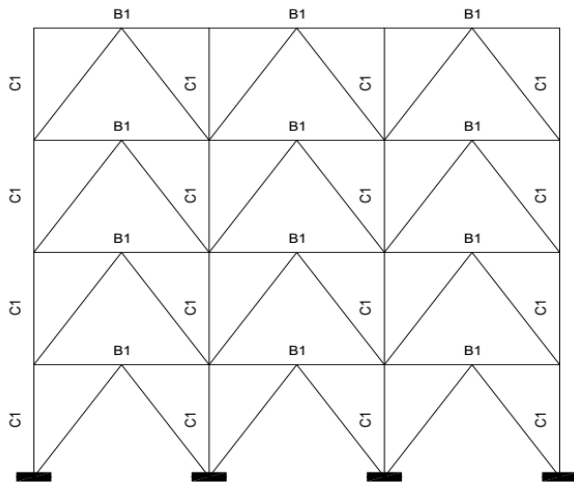

RET 2

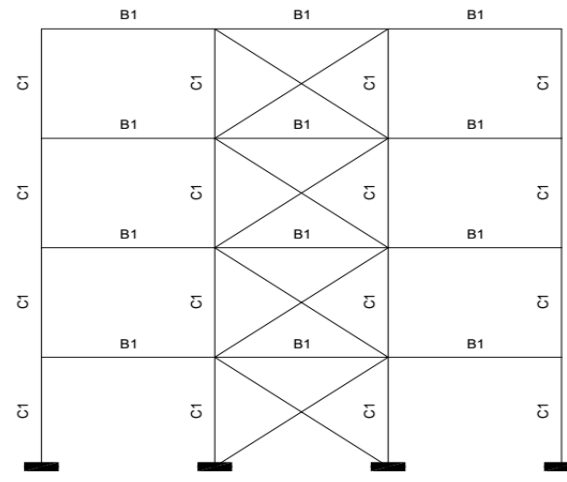

RET 3

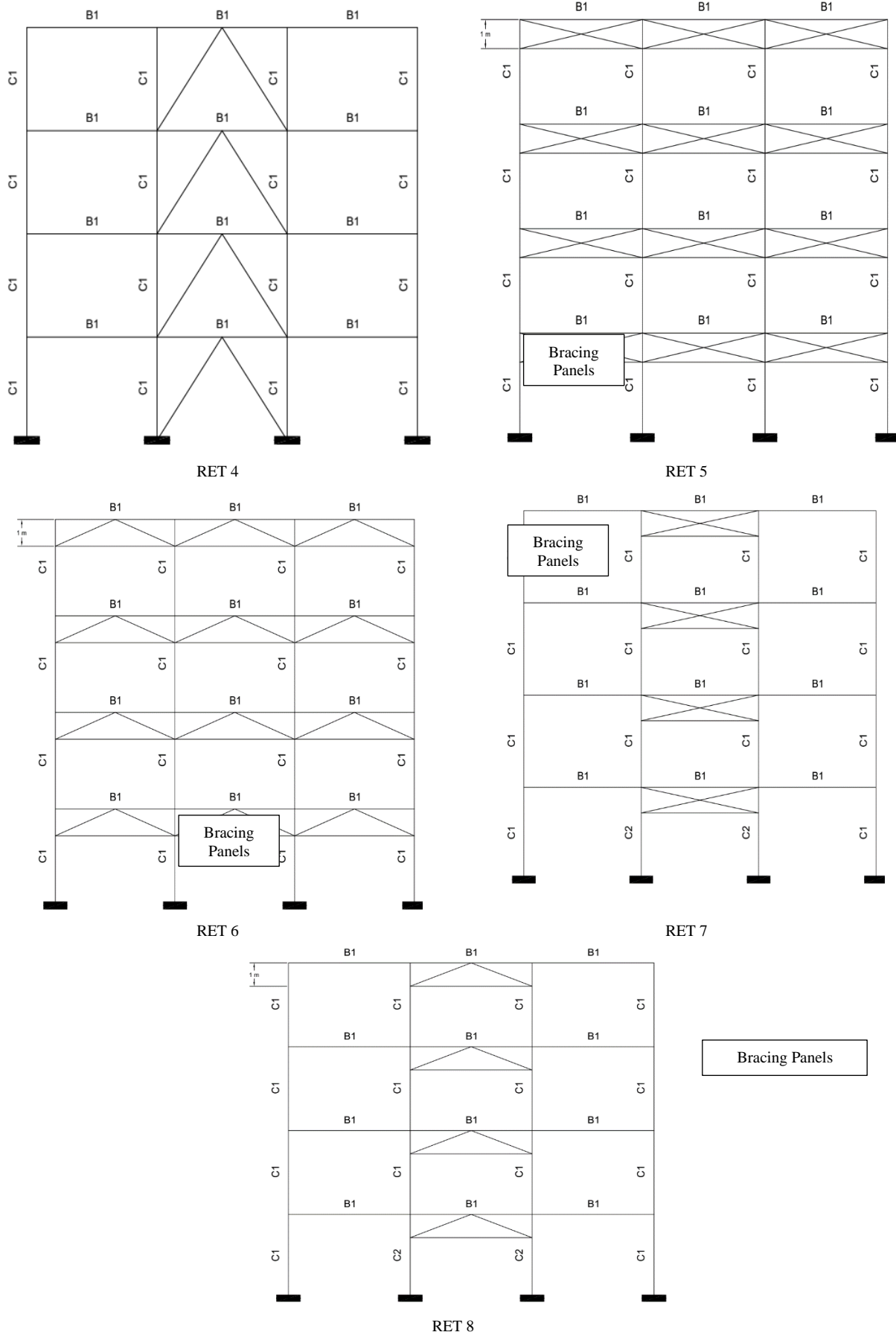

RET 8
Fig. 3: Bracing Modeling [Four Stories]

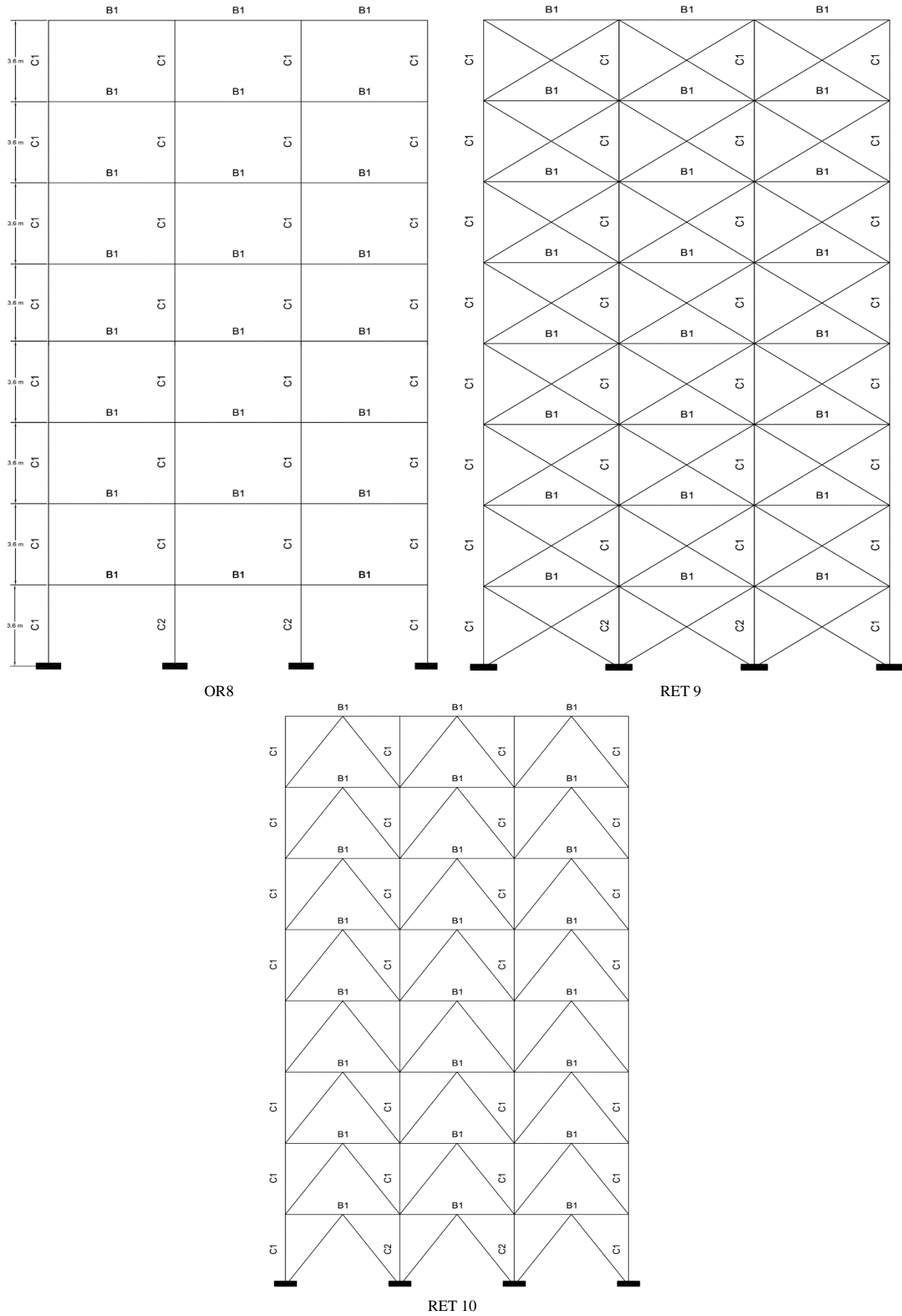
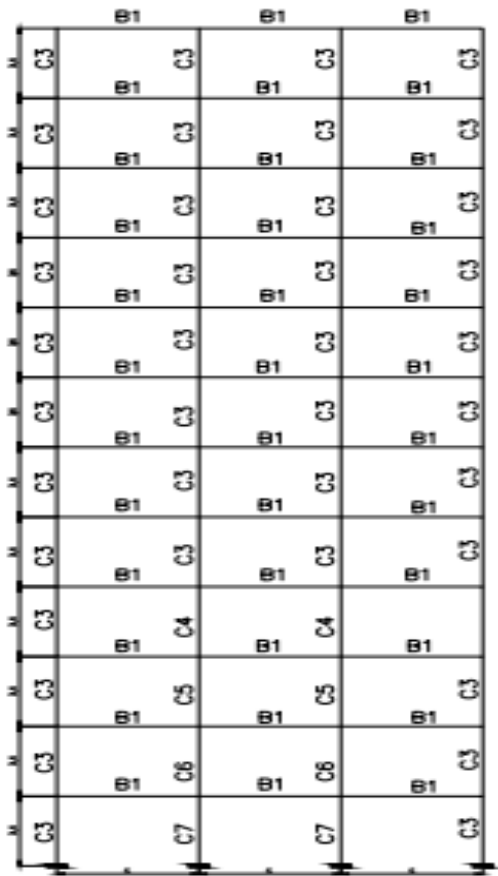
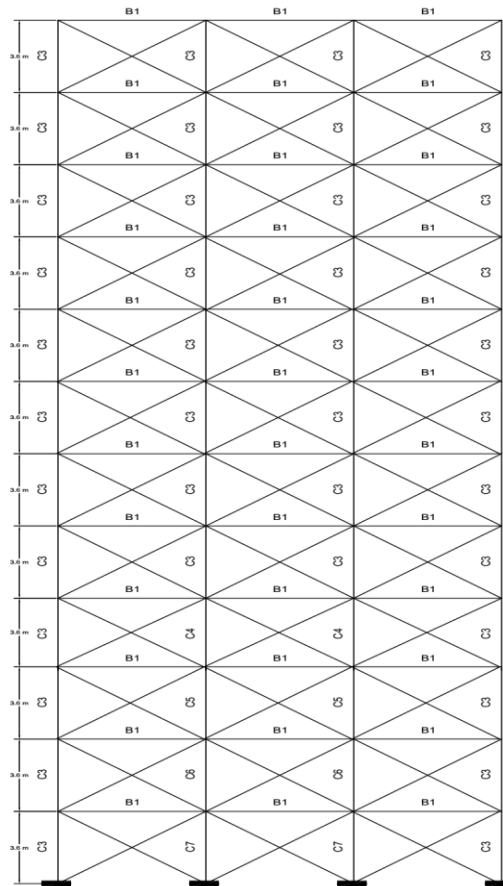

Fig. 4: Bracing Modeling [Eight Stories]



OR12



RET 17

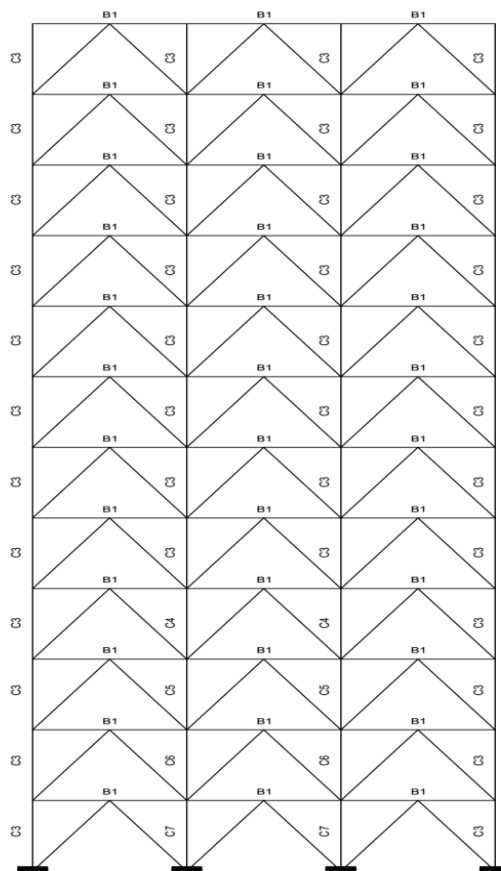

RET 18

Fig. 5: Bracing modeling [Twelve Stories]

3.3. Response Spectrum Analysis [RSA]

Although, an equivalent lateral load approach is restricted in its application due to unconservative conclusions in some cases. This method is still frequently leveraged due to its ease of performing. However, the modal RSA is applicable for all types of structures. On the other hand, the response spectrum [RS] analysis comprises enough modes of vibration in each of two orthogonal orientations to capture at least ninety percentage of the structure's mass [21]. The earthquake region analyzed in this study is region 5B according to the Egyptian code. And the shape of the spectrum is type 1 with a design ground acceleration a_g of 0.3g confirming with the Egyptian code reference. The models are engaged into consideration are residential buildings with an importance factor which is equal to 1. As well as soil factor [S] is equal to 1.5 and, C is the soil class. Besides, the R reduction factor is employed for expressing the resistance of the frame bracing structure system for both vertical loads and total base shear. So, R is equal to 4.5. Also, T_b , T_c , and T_d are equal to 0.1, 0.25, 1.2sec, respectively. Fig.6 describes RS curve.

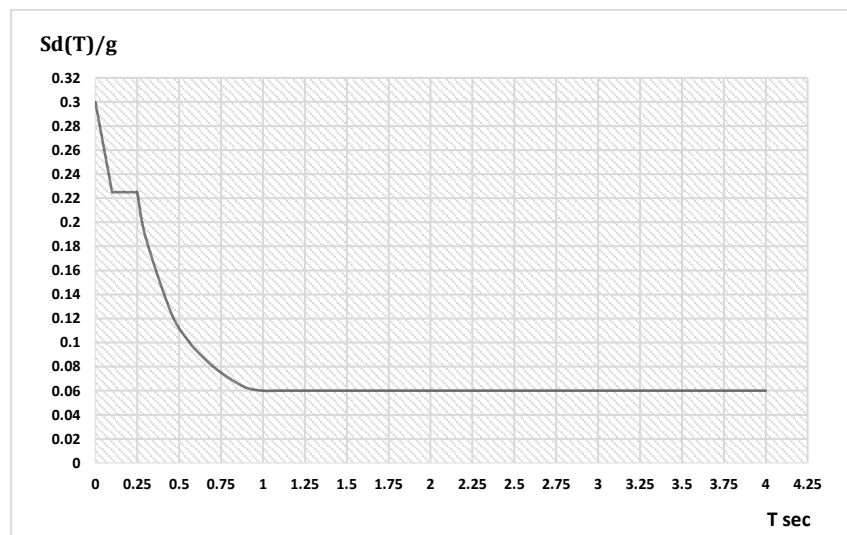

Fig. 6: RS Curve

4. Analysis and discussion

4.1. Lateral displacement and story drift:

Lateral displacement [LD] which is determined from the dynamic features of the structures during an earthquake is one of the most response demands in high-rise building design [22]. In addition, the amplitude of lateral deformations has the potential impact on changing the performance level of building models. And the effects of bracing modeling on lateral displacement demands should be measured in a comprehensive dynamic study to evaluate a structure's realistic performance level. Figures 7 to 9 present the effects of bracing modeling on the story lateral displacement over the height of the RC – frame. The results have demonstrated that:

- First (Four stories): Fig. 7 shows the peak values of the story displacement distribution along models' heights. Models RET1 to RET4 display the highest top displacement response which is less than OR4 by 69.21%, 48.00%, 29.23%, and 24.30%, respectively. Furthermore, Models RET5 and RET6 demonstrate the decrease of the lateral displacement [LD] by 13.64% and 22.39% compared to RM [O4].

- Second (Eight stories): Fig.8 shows the story displacement along the model’s heights. Models RET9 to RET12 display the highest values of lateral displacement which is less than O8 by 74.92%, 58.01%, 43.59%, and 32.45%, respectively. While Models RET13 and RET14 demonstrate the decrease of the LD by 21.10% and 27.30% with respect to RM [O8].
- Third (Twelve Stories): Fig.9 presents the peak values of the story displacement distribution over the model’s heights. Models RET17 to RET 20 display the highest top displacement response which is less than OR12 by 76.85%, 69.98%, 50.6%, and 45.31%, respectively. Furthermore, Models RET21 and RET 22 demonstrate the decrease of the LD by 30.51% and 41% with respect to RM [O12].

Although the seismic performance may be severely impacted, the bracing techniques throughout the building's height led to a decrease in displacement demands compared to RM. Also, adding retrofitting system with a limited BS mechanism can mitigate the response and improve lateral stability.

On other hand, drift and lateral stability should be investigated early in the design process. The LD or SD of a structural system under seismic forces is critical from three main points: 1) structural stability, 2) non-structural component damage, and 3) human comfort during and after construction [23]. Fig.10 presents the drift index as a relationship between relative displacement among contiguous floors and the height of the floor. According to the non-structural elements and their placement in the structure, the EGY code stipulates three levels of allowed SD. For brittle partitions, the acceptable SD ratio is 0.5 percent and, 0.75 percent for ductile partitions. Whereas, SD ratio is 1.0 percent for structural systems with partitions totally isolated from structure motion [24].

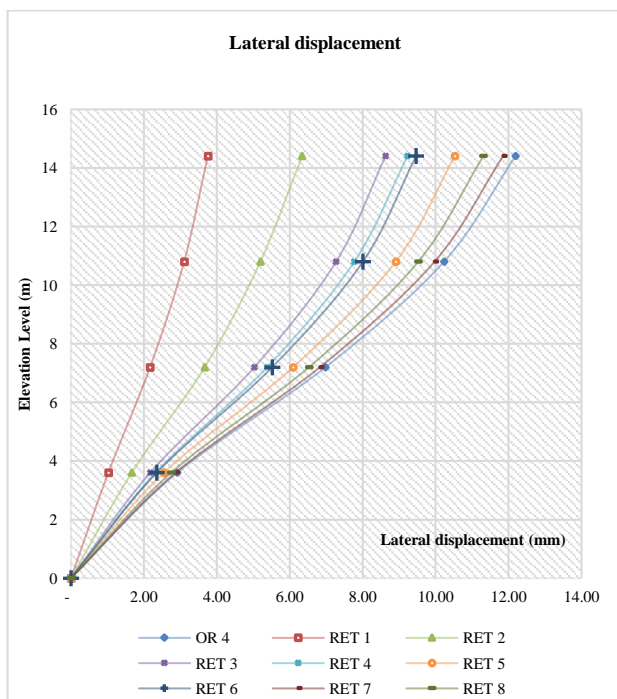

Fig. 7: Lateral displacement [Four Stories]

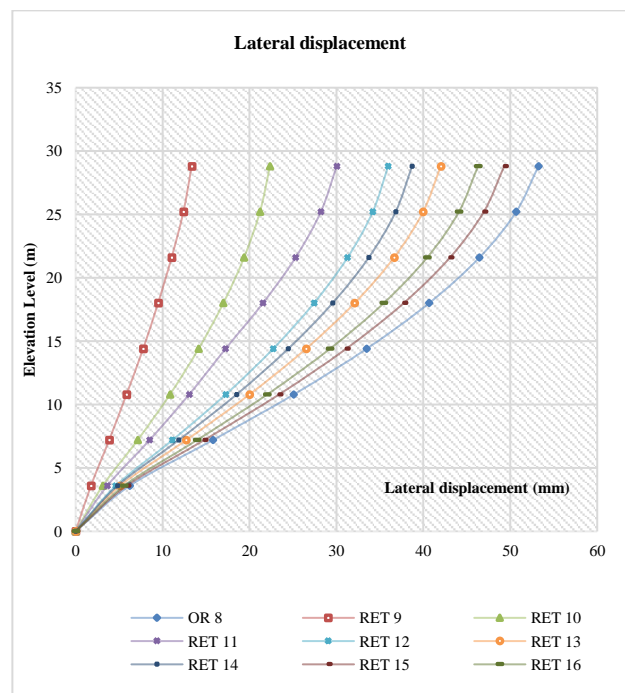

Fig. 8: Lateral displacement [Eight Stories]

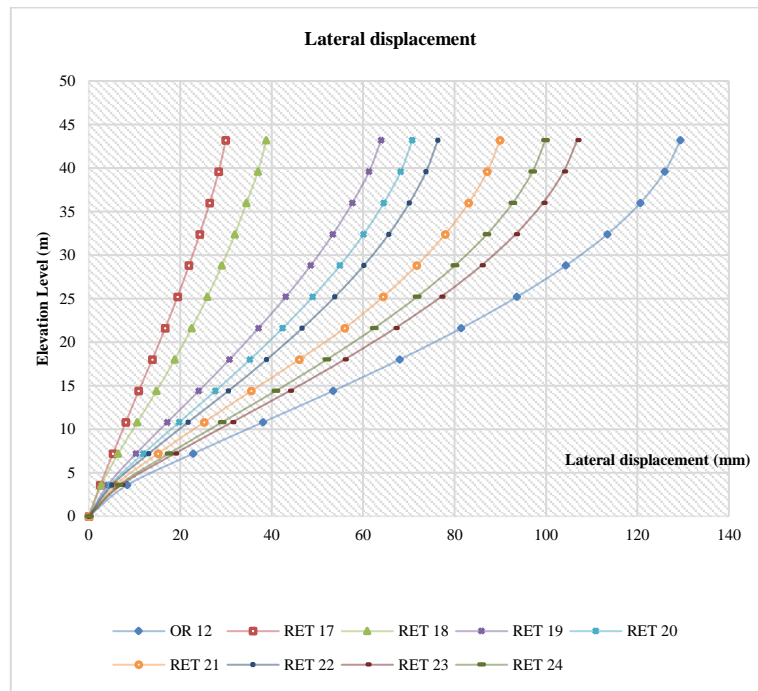

Fig. 9: Lateral displacement [Twelve Stories]

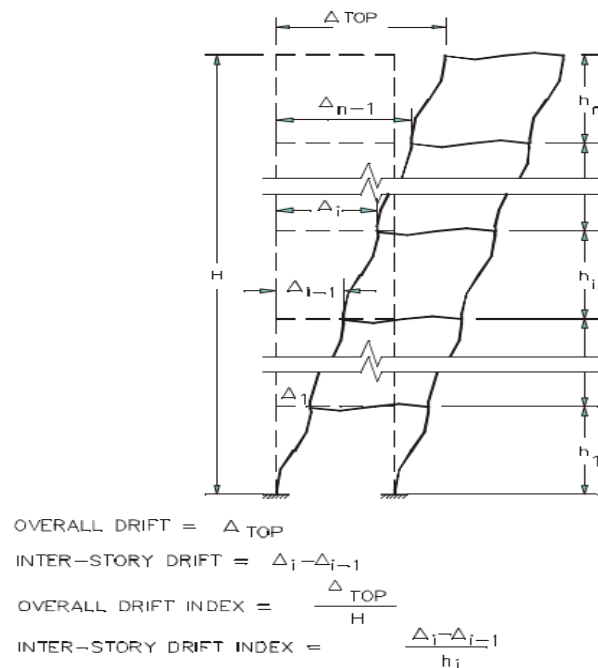

Fig. 10: Drift Index

The story drift ratios [SDR] response demand have been calculated for diverse configurations of the bracing models and compared to RM. Also, the SDR for all BS does not exceed the allowable stipulations in EGY code. Overall, the findings are divided into three cases as follows:

- First (Four Stories): The story drifts [SD] of models rise gradually with the building's height, peaks at the second-story level, and then falls at higher levels. The maximum values of SD response for models RET1 to RET4 are less than RM [OR4] by 71.98%, 51.01%, 30.15%, and 24.88%, respectively. While models RET5 and RET6 establish the decrease of the story drift by 13.42% and 24.88% compared to RM [OR4]. The SD ratios for diverse models are exposed in Fig.11.

- Second (Eight Stories): Also, as previously mentioned, the story drifts of models increase progressively with building height, and its peak value locates at the third story level and then declines at higher levels. The maximum values of SD response for models RET9 to RET12 are less than RM[OR8] by 78.71%,60.15%,41.53%,33.90%, respectively. Furthermore, Models RET13 and RET14 demonstrate the decrease of the SD by 21.70% and 28.18% compared to RM [OR8]. The SD ratios for different models are stated in Fig. 12.
- Third (Twelve Stories): The story drifts increase progressively across the building's height, its peak value locates at the fourth story level, and then declines at higher levels. The maximum values of SD response for models RET17 to RET20 are less than RM[OR12] by 81.54%,72.67%,54.70%,48.25%, respectively. Besides, the models RET 21 to RET 24 have values of SD less than 32.50%,42.46%,17.57%, and 23.16%, respectively, compared to RM [OR12]. Moreover, the SD ratios for different models are presented in Fig.13.

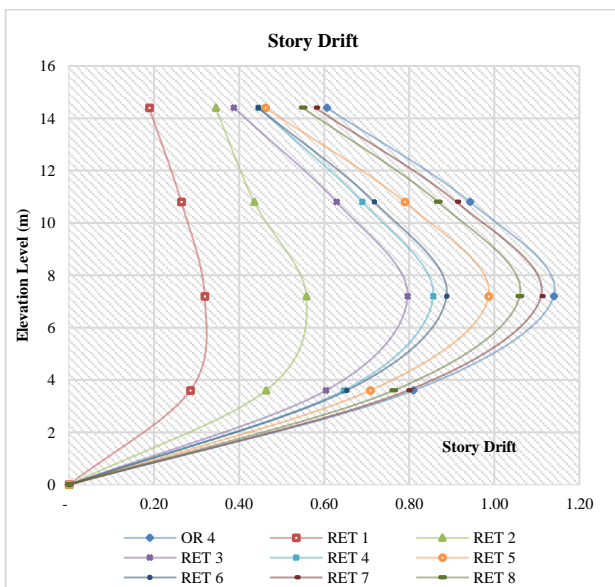

Fig. 11: Story Drift [Four Stories]

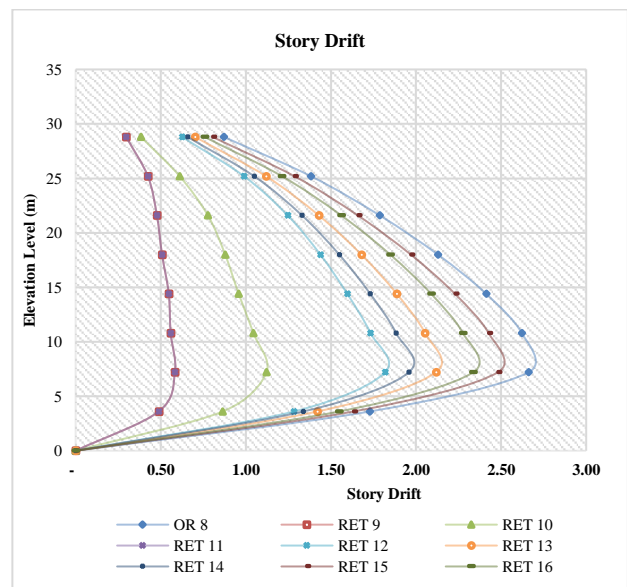

Fig. 12: Story Drift [Eight Stories]

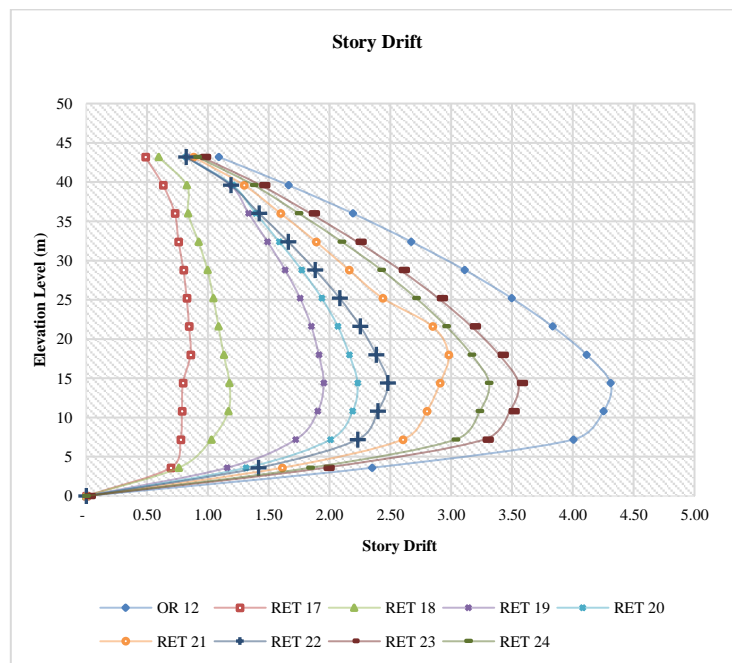

Fig. 13: Story Drift [Twelve Stories]

4.2. Story moment response:

All models of stories [4 & 8 stories]: the existence or absence of the bracing modelling has not affected the moment response. That means the bracing interaction with the RC frame has not a substantial effect on values over the height of the frame. Regarding twelve stories, the reduction of the overturning moment [OM] due to the retrofitting BS can be achieved in the range of 11% to 6.2%. Therefore, the increasing height of the construction can lead to the raising of the impact of the BS. Figures.14, 15, and 16 illustrate the variations of response for all studied cases.

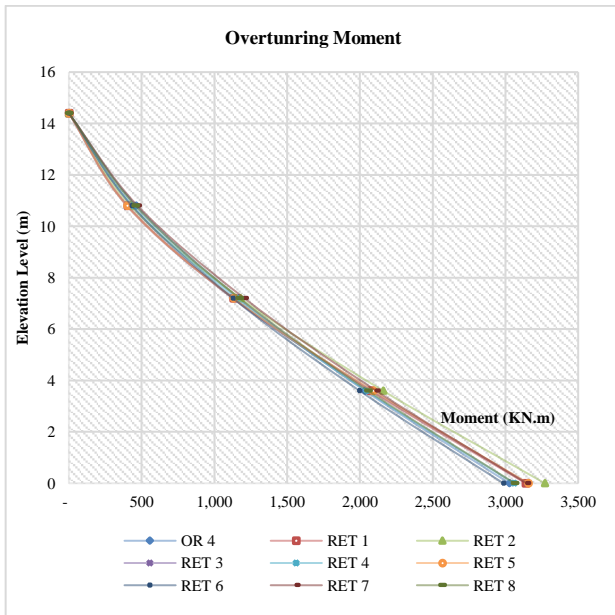

Fig. 14: Overturning Moment [Four Stories]

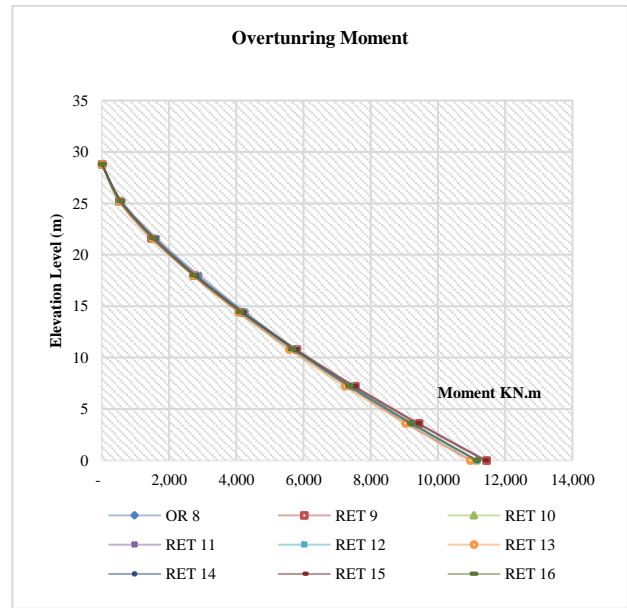

Fig. 15: Overturning Moment [Eight Stories]

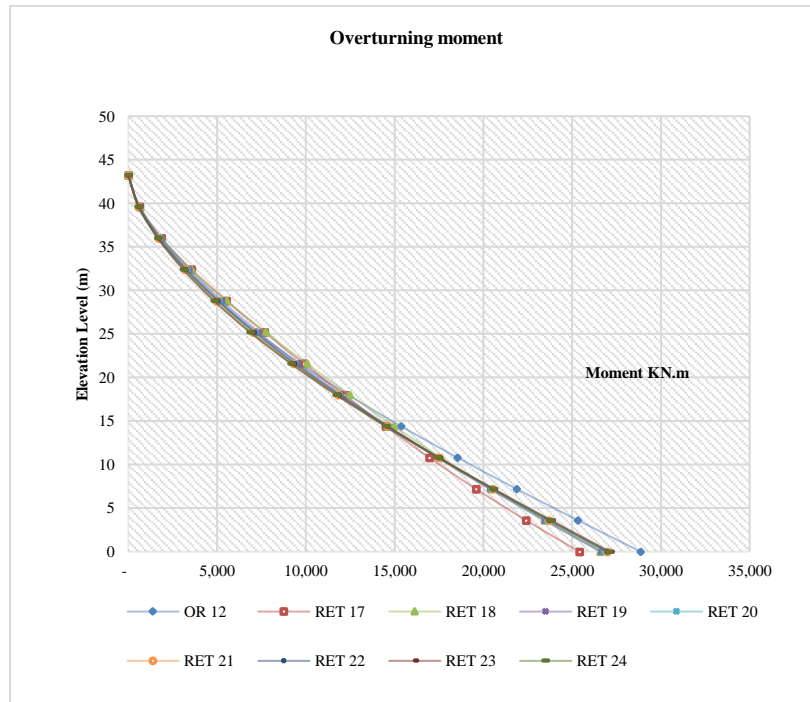

Fig. 16: Overturning Moment [Twelve Stories]

4.3. Story shear response:

The goal of the investigation is to get more information about the seismic performance of the bracing modeling effects. The structural response in terms of story shear and internal forces over the height of the structural elements are measured as response parameters. On other words, these are the most primary response parameters in seismic design. Therefore, the effect of bracing modeling on the story shear response profile over height for 4, 8, and 12-story RC frames has been investigated and compared to RM. For all models of stories [4 & 8 & 12 stories]: The existence or absence of the bracing modeling nearly has a slight effect on the shear response. Figures 17, 18, and 19 display the variations of response for all studied cases.

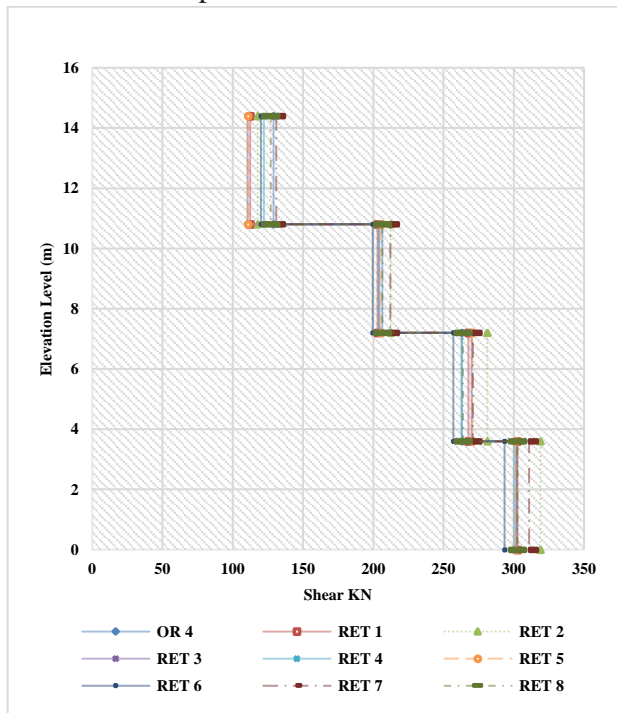

Fig. 17: Story Shear [Four Stories]

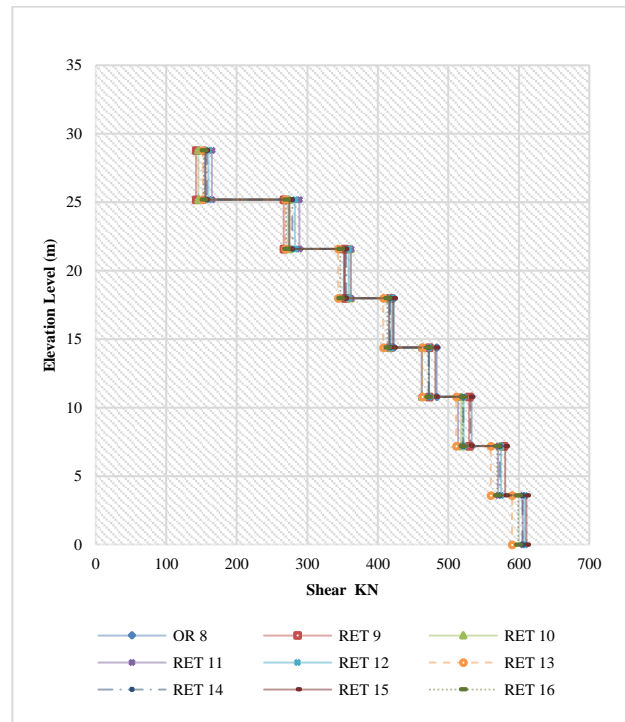

Fig. 18: Story Shear [Eight Stories]

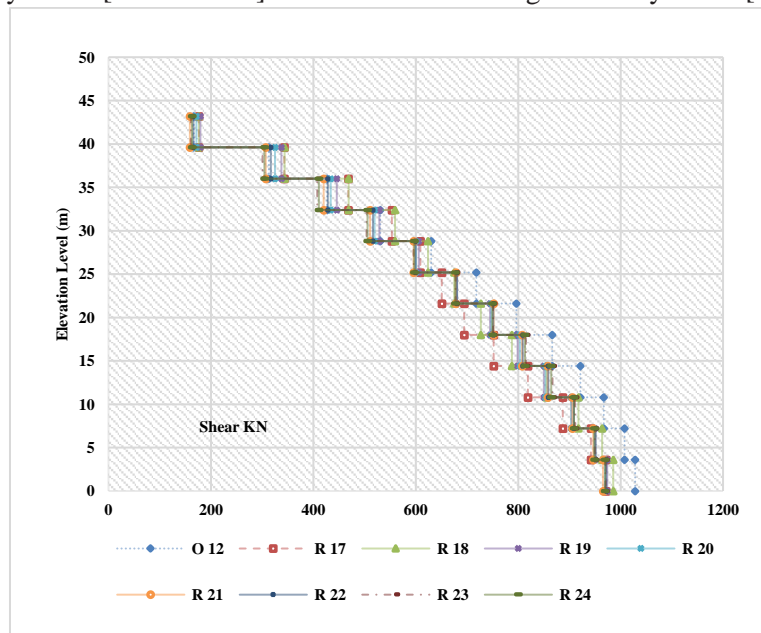

Fig. 19: The Story Shear [Twelve Stories]

On other hand, table 4 shows the ratio between the weight of the used steel in the bracing system and the required steel material for achieving the best performance. The findings demonstrate that: For four stories: Models RET2 and RET6 show not only a decrease in steel ratio by 28.86%, and 15.74%, respectively but also a reduction in the lateral response by 48.00%, and 22.39%. Furthermore, models RET3 and RET7 have a reduction in the steel ratio by 66.67% and 60.39%, respectively while reducing lateral deformation by 29.23% and 2.81%. For eight stories: Models RET10 and RET14 demonstrate not only a decrease in steel ratio by 28.84%, and 15.69%, respectively but also a reduction in the lateral response by 58.01%, and 27.30%. Furthermore, models RET11 and RET15 have a reduction in the steel ratio by 71.17% and 60.38%, respectively while reducing lateral deformation by 43.59% and 7.40%. For twelve stories: Models RET 18 and RET 22 show a decrease not only in steel ratio by 28.86% and 15.72%, respectively but also a reduction in the lateral response by 69.98%, and 41.00%. Furthermore, models RET19 and RET23 have a reduction in the steel ratio by 66.67% and 60.39%, respectively while reducing lateral deformation by 50.60% and 17.46%. In general, the reduction of the steel ratio should be taken into consideration for designing the bracing model to cover the cost factor as the main parameter in the construction industry. In conclusion, the bracing panels of inverted V bracing can be used in reducing the steel ratio while lowering the lateral seismic performance.

Table 4: The ratio of the required bracing material/weight of bracing material model

Modelling code	Bracing Modelling	Weight of braces [kN]	The Ratio of required steel in X bracing and the weight of bracing material model	Performance [The percentage of reducing of lateral displacement in compared with RM]
Four stories				
RET 1	[X bracing [X-B] in all bays]	15.4643	100%	69.21%
RET 2	[Inverted V bracing [IV-B] in all bays]	11.001	71.14%	48.00%
RET 3	[[X-B] in Mid bay]	5.1548	33.33%	29.23%
RET 4	[[IV-B] in Mid bay]	3.667	23.71%	24.30%
RET 5	[1m height of [X-B] in all bays]	18.3771	118.84%	13.64%
RET 6	[1m height of [IV-B] in all bays]	13.03	84.26%	22.39%
RET 7	[1m height of [X-B] in Mid bay]	6.125	39.61%	2.81%
RET 8	[1m height of [IV-B] in Mid bay]	4.344	28.09%	7.25%
Eight stories				
RET 9	[X bracing [X-B] in all bays]	38.7045	100%	74.92%
RET 10	[Inverted V bracing [IV-B] in all bays]	27.5424	71.16%	58.01%
RET 11	[[X-B] in Mid bay]	11.1583	28.83%	43.59%
RET 12	[[IV-B] in Mid bay]	9.1808	23.72%	32.45%

Modelling code	Bracing Modelling	Weight of braces [kN]	The Ratio of required steel in X bracing and the weight of bracing material model	Performance [The percentage of reducing of lateral displacement in compared with RM]
RET 13	[1m height of [X-B] in all bays]	46.0096	118.87%	21.10%
RET 14	[1m height of [IV-B] in all bays]	32.63	84.31%	27.30%
RET 15	[1m height of [X-B] in Mid bay]	15.336	39.62%	7.40%
RET 16	[1m height of [IV-B] in Mid bay]	10.87	28.08%	13.06%
Twelve Stories				
RET 17	[X bracing [X-B] in all bays]	66.6502	100%	76.85%
RET 18	[Inverted V bracing [IV-B] in all bays]	47.4135	71.14%	69.98%
RET 19	[[X-B] in Mid bay]	22.2167	33.33%	50.60%
RET 20	[[IV-B] in Mid bay]	15.8045	23.71%	45.31%
RET 21	[1m height of [X-B] in all bays]	79.857	119.82%	30.51%
RET 22	[1m height of [IV-B] in all bays]	56.17	84.28%	41.00%
RET 23	[1m height of [X-B] in Mid bay]	26.4014	39.61%	17.46%
RET 24	[1m height of [IV-B] in Mid bay]	18.72	28.09%	22.81%

5. Conclusion

This paper investigates the seismic performance of [X- inverted V] bracing equipped with hollow steel sections where these bracing elements are placed between the beam and column joints. The different cases for bracing modeling on the earthquake behavior of RC frames have been evaluated by performing the seismic analysis [RSA]. Each model of the four, eight, and twelve have been analyzed with eight configurations for bracing modelling. Overall, the results of the investigations demonstrate that:

- In 4, 8 and 12-stories frames: The lateral displacement decreases due to the retrofitting system, and it can be a desirable solution for reducing the seismic response. In addition, the reduction in lateral displacement due to X and inverted V in all bays are more than fifty percent compared with a frame without bracing. Moreover, the bracing retrofitting system with limited height [height = 1 m] for both [X-Inverted V bracing] has also an effect on reducing the lateral displacement. Therefore, it can be the best solution to raise the resistance of seismic loading while putting into consideration the architects' requirements.
- The story drift decreases due to retrofitting system [X, inverted V bracing], and its reduction for X and inverted V in all bays reaches more than fifty percent compared with a frame without

bracing. Also, the bracing retrofitting system with limited height [Bracing panels] decreases the values of story drift.

- For both LD and SD ratios, the most effective BS for increasing the ductile frame's lateral stiffness is X bracing. Furthermore, the inverted V bracing is more effective for these responses in the limited height of bracing [Bracing panels].
- In 4, 8 and 12-stories frames, the retrofitting system has a slight effect on the overturning moment and story shears. Otherwise, the increasing height of the building can lead to the raising of the impact of the BS.
- In general, retrofitting low- and medium-rise RC frames with steel X and inverted V bracing benefits MRF in every characteristic. Besides, the X bracing is the utmost effective BS in enhancing the ductile frame's lateral stiffness.
- In conclusion, the reduction of the steel ratio should be taken into consideration for designing the bracing model to cover the cost factor as the main parameter in the construction industry. In addition, the bracing panels of inverted V bracing can be used in reducing the steel ratio while lowering the lateral seismic performance.

References

- [1] Hou X, Tagawa H, "Displacement-restraint bracing for seismic retrofit of steel moment frames," *Journal of Constructional Steel Research*, V. 65, No. 5. 2009, pp. 1096-104.
- [2] Li J, Gong J, Wang L, "Seismic behavior of corrosion-damaged reinforced concrete columns strengthened using combined carbon fiber-reinforced polymer and steel jacket," *Construction and Building materials*, V. 23, No. 7. 2009, pp. 2653-63.
- [3] Ghobarah A, Abou Elfath H, "Rehabilitation of a reinforced concrete frame using eccentric steel bracing," *Engineering structures*, V. 23, No. 7. 2001, pp. 745-55.
- [4] Qiao S, Han X, Zhou K, "Bracing configuration and seismic performance of reinforced concrete frame with brace," *The Structural Design of Tall and Special Buildings*, V. 26, No. 14. 2017, pp. e1381.
- [5] Kadid A, Yahiaoui D, "Seismic Assessment of Braced RC Frames," *PROENG Procedia Engineering*, V. 14. 2011, pp. 2899-905.
- [6] Khan D, Rawat A, "Nonlinear Seismic Analysis of Masonry Infill RC Buildings with Eccentric Bracings at Soft Storey Level," *Procedia engineering*, V. 161. 2016, pp. 9-17.
- [7] Mastrandrea L, Piluso V, "Plastic design of eccentrically braced frames, I: Moment-shear interaction," *JCSR Journal of Constructional Steel Research*, V. 65, No. 5. 2009, pp. 1007-14.
- [8] Antonopoulos T, Anagnostopoulos S, "Assessment and retrofitting of old reinforced concrete buildings with an open ground story," *Book Assessment and retrofitting of old reinforced concrete buildings with an open ground story*, Editor, ed.^eds., City, 2012, pp.
- [9] Hejazi F, Jilani S, Noorzaei J, Chieng C, Jaafar M, Ali AA, "Effect of soft story on structural response of high rise buildings," *Book Effect of soft story on structural response of high rise buildings*, 17, Editor, ed.^eds., IOP Publishing, City, 2011, pp. 012034.
- [10] Sheidaii MR, TahamouliRoudsari M, Gordini M, "Investigation of the nonlinear seismic behavior of knee braced frames using the incremental dynamic analysis method," *International Journal of Advanced Structural Engineering (IJASE)*, V. 8, No. 2. 2016, pp. 151-9.
- [11] Maheri M, Kousari R, Razazan M, "Pushover tests on steel X-braced and knee-braced RC frames," *Engineering Structures*, V. 25, No. 13. 2003, pp. 1697-705.

- [12] El-Amoury T, Ghobarah A, "Retrofit of RC frames using FRP jacketing or steel bracing," *Journal of Seismology and Earthquake Engineering*, V. 7, No. 2. 2005, pp. 83-94.
- [13] Shen J, Seker O, Akbas B, Seker P, Momenzadeh S, Faytarouni M, "Seismic performance of concentrically braced frames with and without brace buckling," *Engineering Structures*, V. 141. 2017, pp. 461-81.
- [14] Rahimi A, Maheri MR, "The effects of steel X-brace retrofitting of RC frames on the seismic performance of frames and their elements," *Engineering Structures*, V. 206. 2020, pp. 110149.
- [15] Castaldo P, Tubaldi E, Selvi F, Gioiella L, "Seismic performance of an existing RC structure retrofitted with buckling restrained braces," *Journal of Building Engineering*, V. 33. 2021, pp. 101688.
- [16] Ohishi H, Takahashi M, Yamazaki Y, "A seismic strengthening design and practice of an existing reinforced concrete school building in Shizuoka city," *Book A seismic strengthening design and practice of an existing reinforced concrete school building in Shizuoka city*, 7, Editor, ed.^eds., City, 1988, pp. 415-20.
- [17] Abou-Elfath H, Ghobarah A, "Behaviour of reinforced concrete frames rehabilitated with concentric steel bracing," *Canadian Journal of Civil Engineering*, V. 27, No. 3. 2000, pp. 433-44.
- [18] Vahedi S, Javadi P, Hosseini MH, "Seismic evaluation of a nonductile soft-first-story RC building retrofitted with steel-braced frames," *Journal of Performance of Constructed Facilities*, V. 33, No. 6. 2019, pp. 04019064.
- [19] Nezamisavojbolaghi K, "Using concentric and zipper steel braces by comparison of effect on improved seismic performance level of concrete moment frame structures with moderate ductility," *SN Applied Sciences*, V. 2, No. 1. 2020, pp. 1-7.
- [20] AISC, "Seismic provisions for structural steel buildings," *Book Seismic provisions for structural steel buildings*, Editor, ed.^eds., AISC Chicago, City, 2010, pp.
- [21] Kunnath SK, Kalkan E, "Evaluation of seismic deformation demands using nonlinear procedures in multistory steel and concrete moment frames," *ISET Journal of Earthquake Technology*, V. 41, No. 1. 2004, pp. 159-81.
- [22] Wada A, "Drift control method for structural design of tall buildings," *Book Drift control method for structural design of tall buildings*, Editor, ed.^eds., City, 1991, pp. 425-34.
- [23] Naeim F, "Design for drift and lateral stability," *The seismic design handbook*, Springer, 2001, pp. 327-72.
- [24] Abou-Elfath H, Ramadan M, Meshaly M, Fdiel HA, "Seismic performance of steel frames designed using different allowable story drift limits," *Alexandria engineering journal*, V. 56, No. 2. 2017, pp. 241-9.

استخدام أنظمة التدعيم لتحسين الأداء الزلزالي للإطارات المقاومة للعزوم

الملخص بالعربي:

تم اعتماد أنظمة التدعيم [BS] على نطاق واسع كنظام مقاومة للأحمال الجانبية في المباني المتوسطة والعالية الارتفاع بسبب الصلابة الجانبية وقدرتها على مقاومة الأحمال الأفقية، وتعتبر من أكثر الطرق فاعلية لدمج مع الهياكل الخرسانية. لذلك، تم دراسة الاستجابة الزلزالية للإطارات المقاومة للعزوم باستخدام أنظمة التدعيم [SBF] المرتبطة بالأعمدة. وقد تم فحص تكويناتها المختلفة لدراسة آثارها على مقاومة الحمل الجانبي والحصول على أفضل سلوك انشائي. علاوة على ذلك، لا تهتم الدراسة فقط بدراسة أنظمة التدعيم BS على ارتفاع المبنى بالكامل، ولكنها أيضاً تقلل من ارتفاعها المستخدم وبالتالي تقلل من طول عناصر التدعيم التي يمكن أن تؤدي إلى زيادة مقاومة التحميل الزلزالي. بالإضافة إلى ذلك عناصر التدعيم محدودة الارتفاع تفي بمتطلبات المهندسين المعماريين. لذلك، يمكن اختيار الدعامات الأصغر التي تفي بمتطلبات التي تفرض من قبل الممارين بتقليل الارتفاعات للدعامات المعدنية لدراسة. وقد تم تحليل السلوك الزلزالي للهيكال الذي تم تدعيمها باستخدام أشكال وأنماط مختلفة من الدعامات المعدنية SB (X، V مقلوبة). توضح النتائج أن مكونات الدعامات محدودة الارتفاع لكلا من نظام المقصات X ونظام V المقلوبة تساهم في تقليل الإزاحات الجانبية والحد الأقصى للانحراف الطبعي.