



An efficient and reliable OFDM channel state estimator using deep learning convolutional neural networks

Received 2 June 2023; Revised 5 September 2023; Accepted 6 September 2023

Hassan A. Hassan¹
Mohamed A. Mohamed²
Mohamed H. Essai³
Ahmed S. Mubarak⁴
Hamada Esmail⁵
Osama A. Omer⁶

Keywords

OFDM, channel state estimation, signal detection, machine learning, deep learning, and convolutional neural networks.

Abstract

Orthogonal frequency division multiplexing (OFDM) wireless systems rely heavily on channel state estimation (CSE) to mitigate the effects of multipath channel fading. Achieving a high data rate with OFDM technology requires efficient CSE and accurate signal detection. In contrast to more traditional CSE methods that depend on a model-based strategy, machine learning (ML)-based CSE techniques have attracted increased interest in recent years due to their data-driven, learning-based flexibility. In light of this, a deep learning (DL) convolutional neural network (CNN) is utilized to acquire reliable CSE over OFDM wireless system Rayleigh-fading channels. The suggested CSE utilizes offline training to gather channel information from transmit/receive pairs. In addition, it employs pilots to provide additional guidance on channels of communication. The proposed CNN-based estimator is compared to conventional estimation approaches and state-of-the-art DL channel estimators using SER analysis. The simulation results show that the proposed CNN estimator provides far superior SER performance compared to the conventional LS and MMSE estimation methods. Also, the proposed CNN CSE performs similarly to the DL BiLSTM estimator with restricted training pilots (8). Furthermore, CNN CSE beats DL BiLSTM with enough training pilots (64). The simulation findings also confirm that the suggested CNN-based CSE is efficient/reliable with (16 and 8) or without cycle prefixes (CP). This, in turn, reduces the bandwidth required to convey the same quantity of data. In addition, there is no background knowledge of the channel's statistics in the proposed estimator. Consequently, the proposed method shows potential for addressing CSE issues in OFDM systems with a significant spectrum resource reduction.

¹ Department of Electrical Engineering, Faculty of Engineering, Al-Azhar University, Qena. hassanali2720.el@azhar.edu.eg

² Dept. of Electrical and Electronic Engineering, Al-Azhar University, Qena. mohammed.anbar@azhar.edu.eg

³ Electrical Eng. Depart, Faculty of Engineering-Qena, Al-Azhar University, Egypt. mhessai@azhar.edu.eg

⁴ Dept. of Electrical and Electronic Engineering, Aswan University, Abulrish, Aswan. ahmed.soliman@aswu.edu.eg

⁵ Dept. of Electrical and Electronic Engineering, Aswan University, Abulrish, Aswan. h.esmaiel@aswu.edu.eg

⁶ Dept. of Electrical and Electronic Engineering, Aswan University, Abulrish, Aswan. omer.osama@aswu.edu.eg

1. Background and Motivation

OFDM is a crucial technology in the 4G and 5G standards for communications over wireless networks. It provides higher spectrum efficiency and supports the increasing need for data throughput and capacity [1]. Because of its importance in a wide variety of wireless communication network tasks, including signal recovery, interference mitigation, channel equalization, and resource allocation, CSE is an important problem that must be addressed [2], [3]. The communication efficiency of a wireless system relies heavily on the quality of the CE method. Using precise channel state information (CSI), it is possible to attain high levels of efficiency/reliability in wireless communications.

Generally, CSE techniques fall into one of three groups depending on whether or not preceding knowledge is used: pilot-based estimates, blind estimations, and semi-blind estimations [4]. Pilot-based estimation approaches, in particular, assign a portion of wireless resources to send known signals to acquire CSI. Pilot-based channel estimators are applicable to any wireless communication system because of their minimal computational complexity. Nonetheless, their primary drawback lies in reducing the transmission rate due to the insertion of pilot signals. By exploiting the incoming signal's statistics and structure, blind estimations methods perform CSI without requiring pilots, resulting in improved transmission. Despite the potential for superior performance, most wireless standards prefer Pilot-based channel estimators. This choice may be due to the blind channel estimations techniques' poor results [5]. Semi-blind estimation methods combine the benefits of both pilot-based/blind estimation methods, leading to improved performance with minimal training sequence or pilot transmission [6].

The least squares (LS) and minimum mean square error (MMSE) channel estimator algorithms are commonly employed for pilot-based CSE. Because it is easy to implement and is independent of any previous information regarding the channel state, the LS approach has seen extensive application. However, degradation in performance caused by estimation errors due to noise reduces its usefulness [7]. In contrast, the MMSE estimator improves estimation results by exploiting the noise variance and the channel's statistical features, but at the expense of increased complexity. Furthermore, in real-world wireless applications, precisely estimating channel statistical characteristics might be challenging [8]. The evolution of wireless networks has resulted in an ever-increasing level of complexity. However, the majority of modern wireless systems are conceived using mathematical models. The potential for general solutions is reduced because these mathematical models differ depending on the scenarios and, in many cases, do not learn from the past or system patterns.

To overcome the above restrictions, applying ML techniques to wireless communication networks is the subject of extensive research [9]. A general learning system independent of any specified model can be created using the ML-based design's prediction/estimation capabilities [10]. Recently, DL, a prominent form of ML, has become an attractive choice for wireless transmission scenarios with uncertain [11] or complex channel circumstances [12]. Due to the variable nature of channel circumstances as well as the need for estimation/training required to determine channel coefficients, DL is well-suited to issues like CSE. In the realm of DL, CNN ranks among the most essential networks [13]. CNN excels in numerous fields, particularly the processing of natural languages [14] and computer vision [15]. A CNN-based solution is chosen in the current study since the CSE issue can be represented as an image-processing problem. Because it uses parameter sharing/sparse

connections to minimize the number of parameters in the weight matrix compared to a fully connected neural network (FCNN) model, the CNN-based DL approach has proven effective for handling image processing challenges [16].

2. Related Work and Our Contribution

Numerous wireless communications applications have benefited from the utilization of DL algorithms [17]-[22]. Within the context of the CSE application, with the integration of a CNN plus a batch normalization layer, the authors in [23] offered a recurrent neural network (RNN) for signal detection tasks in a time-varying OFDM system using a bidirectional long short-term memory (BiLSTM) framework. Findings from simulations proved that the recommended method could improve detection efficiency compared to traditional CE algorithms. To execute combined CSE and signal detection in a multiple input multiple outputs (MIMO)-OFDM system, the authors in [24] presented a system that integrates compression sensing (CS) with a DL BiLSTM framework. The findings of the investigation showed that the suggested technique exceeded standard approaches.

For the IEEE 802.11p standard, the authors in [25] presented a DL-based CE method. The introduced estimator first estimates the channel utilizing a long short-term memory (LSTM) unit, then uses temporally average (TA) processing to reduce noise. Experimental results demonstrated that the suggested techniques outperform the latest presented DL-based estimators. In [26], a DL-based CE network (ChanEstNet) was utilized to extract the feature vectors from channel responses using a CNN-based technique, and then those features fed into a LSTM RNN for the CE task. The outcomes of the simulations demonstrated that the suggested technique provides superior CE quality in high-speed mobile scenarios. Using LSTMs, the authors of [27] presented a DL CE technique applicable to OFDM systems across many different models of channels. According to simulation outcomes, the proposed DL estimation method obtains superior CE accuracy compared to the traditional MMSE and LS estimators. The authors in [28] presented two deep neural network (DNN) structures for the CE task in a 5G MIMO-OFDM system under the scenario of frequency selective fading. The simulation findings showed that the suggested DL-based CE approach performed better than traditional linear MMSE (LMMSE) and LS methods.

To aid in the CE task in 5G MIMO-OFDM systems under various fading multi-path channel scenarios, the authors in [29] used multiple DNN designs, including CNN, FCNN, and Bi-LTSM. Compared to the conventional CE methods, the proposed DL-based framework showed superiority in the simulation results. In [30], the authors offered DeepRx, a fully CNN framework to develop an outstanding-performance OFDM receiver from the data that complies with 5G standards. The outcomes of the simulations showed that the suggested DL framework outperformed traditional methods for the CE task. In study [31], the authors proposed using a DL-gated recurrent unit (GRU) neural network for CE in an OFDM wireless system. The simulation results demonstrated that the suggested DL-based CE provides outstanding performance compared with conventional and other channel estimators in a limited number of pilots. In [32], a DL-based CE approach was proposed for OFDM systems operating over phase-noisy and selective fading channels. For efficient learning and tracking of channel change in the time/frequency domains, two-dimensional (2D) CNNs have been employed. The numerical results show that robust OFDM performance is achieved even with a degree of phase noise using the suggested framework. A one-dimension (1D) CNN-based channel

estimation/equalization technique for OFDM systems was introduced in [33]. The outcomes of the simulations indicated that the proposed structure is more effective for both conventional and feed-forward neural network (FFNN) estimators. Table 1 presents a summary of the relevant state-of-the-art techniques included in this study.

Table 1: Summary of relevant literature

Reference	DL Method	Performance	Limitations
[23]	CNN + Batch Normalization + BiLSTM	Improved detection efficiency in time-varying OFDM	The complexity of the overall model architecture is increased by incorporating CNN, BN, and RNN in the proposed approach, known as CNN-BN-RNN Network (CBR-Net). Specifically, they employed a signal detection task.
[24]	DL BiLSTM + Compression Sensing (CS)	Exceeded standard approaches in MIMO-OFDM	The proposed approach, combining the compressed sensing method and the Bi-LSTM approach, demands substantial computational resources, particularly when implementing it in real-time scenarios.
[25]	DL-based CE with LSTM + Temporally Average (TA) processing	Outperformed latest DL-based estimators for IEEE 802.11p	The suggested technique uses Temporally Averaged (TA) processing with the LSTM approach, which requires a lot of computational capacity, especially in real-time applications.
[26]	ChanEstNet (CNN + LSTM)	Superior CE quality in high-speed mobile scenarios	The complex structure of ChanEstNet combines CNN for channel response feature extraction and LSTM for channel estimation.
[27]	DL CE technique with LSTMs	Superior CE accuracy compared to MMSE and LS estimators for OFDM systems	Inadequate performance is shown by the proposed DL channel estimation method, which achieves results on par with the MMSE estimator.
[28]	Two DNN structures for CE in 5G MIMO-OFDM	Outperformed LMMSE and LS methods under frequency selective fading	The solution that has been proposed does not make full use of DL and instead uses LS estimate as the input.
[29]	Multiple DNN designs (CNN, FCNN, Bi-LSTM) for CE in 5G MIMO-OFDM	Superiority over conventional CE methods	The suggested channel estimation approaches involve integrating a general DNN with a conventional channel estimation method, resulting in increased complexity.
[30]	DeepRx (Fully CNN framework)	Outstanding CE performance for 5G OFDM	The main emphasis of the suggested channel estimation scheme is on the performance improvements obtained through DL, with limited consideration given to the potential high computational complexity involved.
[31]	DL-gated recurrent unit (GRU) neural network for CE in OFDM	Excellent performance with limited pilots over typical CE approaches	Challenges related to data generation, generalization, and model optimization need to be carefully addressed to ensure the reliable and robust performance of the estimator in practical scenarios.
[32]	DL-based CE with 2D CNNs for OFDM over	Robust OFDM performance even	Estimating channel variations in both the frequency/time domains adds complexity to

Reference	DL Method	Performance	Limitations
	phase-noisy and fading channels	with phase noise	the learning process, as it requires the network to capture temporal and spatial dependencies effectively.
[33]	1D CNN-based channel estimation/equalization technique for OFDM	More effective than conventional and FFNN estimators	The proposed approach heavily relies on appropriate network architecture and sufficient training information for efficient performance.

In this study, we propose using CNN to create a DL-based CSE for symbol categorization in OFDM systems. The suggested CNN architecture is offline-trained for CE using simulated data. Once the DL model has been trained, it can be utilized online to extract the sent data without relying on explicit CSI estimation. We analyze how well the suggested structure for channel estimation works in various scenarios with varying CP lengths and pilots' density. Moreover, a priori knowledge of channel information is unnecessary for the proposed CSE. To the authors' knowledge, it is the first work to offer and assess CNN-based CSE without merging additional deep NN techniques employing short/without cyclic prefixes.

Symbol error rate (SER) simulations are utilized to assess the accuracy of the suggested estimator and compare it with conventional estimation algorithms. In addition, the suggested framework's efficiency is evaluated against existing data-driven techniques, such as the DL BiLSTM model utilized in [23, 24]. The adaptive moment estimation (Adam) algorithm trains the proposed estimator on synthetic datasets. Also, a loss function based on cross-entropy is employed.

Based on the results of the simulations, the suggested CNN framework significantly outperforms the traditional LS and MMSE estimation techniques regarding SER performance in all scenarios. Additionally, while using restricted training pilots, its performance is on par with the DL BiLSTM structure used in [23, 24]. When sufficient training pilots are used, the CP is missed, and no prior knowledge of CSI is used, the proposed CNN CSE outperforms its competitor, DL BiLSTM.

The remaining sections of this work are structured as follows. The OFDM system model is presented and discussed in Section 3. Then, in Section 4, we describe the suggested CNN CSE and its learning methods. In addition, Section 5 analyzes the SER performance of the considered estimators and illustrates the resulting simulation findings. In the end, Section 6 summarizes this study.

3. System Description

Figure 1 shows the architecture of an OFDM system that utilizes the proposed DL-based CSE. The OFDM baseband system is identical to the traditional ones. On the transmitting end, a serial-to-parallel (S/P) converter first converts the serial stream of symbols and pilot signals into a parallel stream of data. After processing by an inverse discrete Fourier transform (IDFT), the data is now in the time domain rather than the frequency domain employed by the transmitter. Then, a cyclic prefix (CP) is appended to the symbol string to reduce inter-symbol interference (ISI).

The multipath channel of a sample space characterized by complex random variables $\{h(n)\}_{n=0}^{N-1}$ is considering. The signal received $y(n)$ can be represented as [34]:

$$y(n) = x(n) \square h(n) + w(n), \quad (1)$$

Where the vectors $x(n)$ and $h(n)$ are the time domain transmitted and channel coefficients, the operator \otimes represents a circular convolution, and the vector $w(n)$ represents zero-mean additive white Gaussian noise (AWGN). Once the CP has been eliminated and discrete Fourier transform (DFT) has been performed, the resulting frequency-domain signal is:

$$Y(k) = X(k)H(k) + W(k), \quad (2)$$

Where the vectors $X(k)$, $H(k)$, $W(k)$ and $Y(k)$ are the DFT of $x(n)$, $h(n)$, $w(n)$ and $y(n)$, respectively.

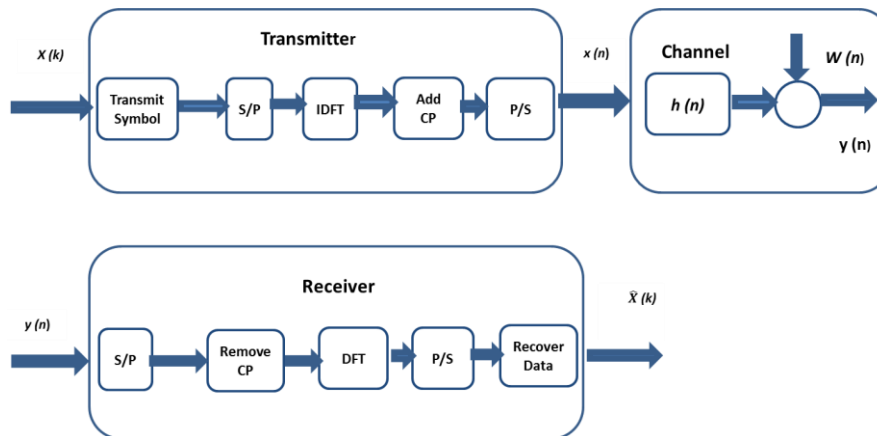

Fig.1: OFDM transmitter/receiver structure diagram.

4. The proposed CNN CSE and its learning methods

4.1. The proposed CNN structures

The CNNs are a globally utilized algorithm for identification/classification, particularly in pattern recognition and image processing. It has evolved to the point that it is now considered one of the most representative NNs in the DL field [35]. By integrating numerous layers of processing—such as convolution layers, pooling layers, and fully connected layers—a CNN can automatically/adaptively learn from low- to high-level spatial hierarchies of features via backpropagation. Features are retrieved by the first two layers (convolution and pooling) and then mapped to the final output (classification, for example) by the third layer (a fully connected one) [36].

The proposed CNN framework uses an array of layers, including a single 2D input layer initially, two convolution layers, two-layer batch normalization, two nonlinear activation layers, a single fully connected layer, and, at last, a single SoftMax and classifier layer to provide probabilities for each output class. Figure 2 illustrates the components of the implemented architecture for the proposed DL CNN-based CSE.

After conducting extensive research using various architectures containing different numbers of convolutional layers, we decided to incorporate only two convolutional layers in the proposed design. Our decision was based on finding a balance between efficiency/complexity.

Several benefits may result from CNN-based architectures that employ just a few convolutional layers. One of these advantages is efficiency, which CNN-based designs may be able to improve by using fewer convolutional layers because they learn more quickly. Because there are fewer parameters to learn/compute, this model is well suited for application in real time. Another advantage is that more straightforward architectures are less complex and require less time to learn and analyse. In addition, a simpler model with fewer convolutional layers may be less likely to overfit and have lower memory requirements [13].

A quick summary of the numerous layers included in the proposed CNN model's framework is provided in the following subsections:

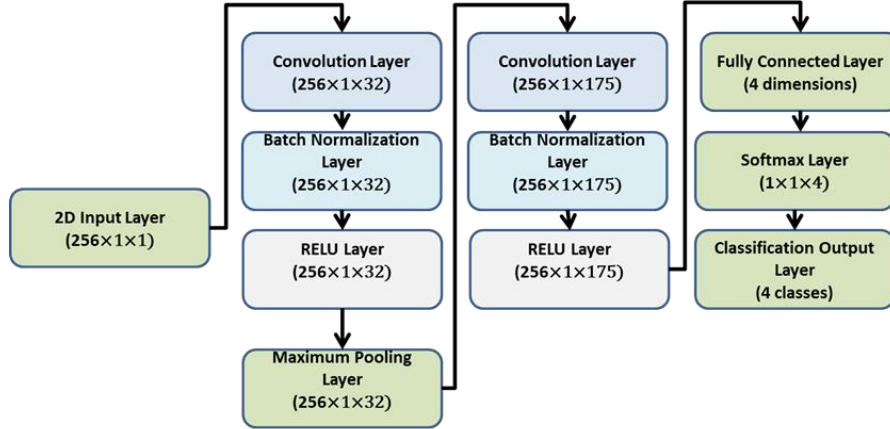

Fig.2: The proposed CNN estimator's layer layout.

4.1.1. Convolutional Layer (CL)

One of the fundamental components of a CNN is a CL, which extracts essential features from the input image by convolving it with the learnable filters (kernels). After the convolution with the input image, each filter generates an activation map.

Consider that N_s defines the number of inputs, l^{th} denotes the specified input length, L_s^l describes the layers of convolution of the proposed CNN estimator, L_k^l represents the length of the filters in the l^{th} layer, and N_k^l symbolizes the number of filters in the l^{th} layer. For the l^{th} layer, the convolutional process is mathematically represented as follows [37]:

$$h_k^l = f(x^l \times w_k^l + b_k^l), \quad (3)$$

Where $f(\cdot)$ denotes the selected activation function, $x \in \mathbb{R}^{N_s \times L_s^l}$ defines the input feature map of layer l , $b \in \mathbb{R}^{N_s}$ indicates the bias terms associated with the outputs, $w \in \mathbb{R}^{N_k^l \times L_k^l}$ describes a collection of filters for the l^{th} layer, and $h^l \in \mathbb{R}^{N_k^l \times L_s^l}$ symbolizes the feature map, which is the set of output feature maps for layer l . Also, the value of the outcomes of the k^{th} filter can be expressed as:

$$(x^l \times w_k^l)(i) = \sum_{a=-\infty}^{\infty} x(a)w_k^l(i-a), \quad (4)$$

The above equation describes how the convolution operation is applied to compute the value of the output for each position i in the feature map produced by the k^{th} filter in layer l .

4.1.2. Batch Normalization (BN) Layer

Many challenges must be overcome when training DNNs. Although they have tremendous potential, they are sometimes slow and susceptible to overfitting. Therefore, there is a continuous effort in DL research toward discovering solutions to these issues. One of these methods is known as "batch normalization". The BN layer aims to speed up the process of training the DNNs by minimizing the change in the network's internal covariance and enhancing its overall efficiency. Typically, the BN layer is placed between the convolution and activation layers.

4.1.3. Pooling Layer

Using pooling layers in CNNs is intended to decrease the total number of parameters and, consequently, the model's complexity by gradually decreasing the dimensionality of the representation. Additionally, the pooling layer boosts the efficiency of the model. Among the most common types of pooling operation, "max pooling", which returns the highest value detected in the pooling filter, is utilized in this study.

4.1.4. Rectified Linear Unit (ReLU) Layer

An essential part of a CNN is the activation function. Typically, a nonlinear activation function is utilized for mapping the obtained features, thus preventing the problem of insufficient expression resulting from the linear operation. One of the most well-known nonlinear activation functions, known as ReLU, is used in the proposed model, and is described as:

$$f(x) = \begin{cases} x, & x \geq 0 \\ 0, & x < 0 \end{cases} \quad (5)$$

4.1.5. Fully Connected (FC) Layer

A FC layer for the ultimate justification and classification may be present following the stacking of many layers for feature extraction tasks. The FC layer is precisely what its name implies since each FC layer output node connects directly to a previous layer node. A single FC layer is used after the convolutional layer in this study. The result of the extraction of features process is a feature map in the form of a multidimensional array, which must be flattened or transformed into a vector before it can be used as the input for the FC layer. For CSE issues, the FC layer plays a vital role as it integrates the features gained from lower-level layers over the entire transmission channel to estimate channel state information.

4.1.6. Output Layers (Softmax/Classification)

The softmax layer is highly regarded as an effective tool for representing class distribution. In tasks that require classification, a softmax layer typically comes before the classification layer. Using a softmax function, the outcome of the previous FC layer turns into a normalized estimated probability in the range $[0, 1]$. The softmax function can be represented as follows:

$$p_j = \frac{e^{x_j}}{\sum_{n=1}^N e^{x_n}}, j = 1, \dots, N \quad (6)$$

Where p_j denotes the likelihood of the i^{th} class between the j classes.

The classification layer frequently appears after the layer of softmax in standard classifiers. The classification layer receives the softmax function's outcome and utilizes a specified loss function, cross-entropy in this study, to assign each value to one of the possible classes. The primary loss function employed in the current study for speeding up training is cross-entropy, which can be represented for the k mutually exclusive categories as [38]:

$$\text{Crossentropy} = -\sum_{i=1}^N \sum_{j=1}^C x_{ij}(k) \log(\hat{x}_{ij}(k)), \quad (7)$$

Where C symbolizes the total number of categories, e sample size, indicates the whole N is an outcome of the \hat{x}_{ij} category, and i^{th} data sample delivered for the i^{th} identifies the x_{ij} suggested estimator for a sample i in category j .

4.2. Training procedures for the proposed model

An efficient DL CNN model for CSE was achieved through a two-phase procedure. In the initial phase, OFDM samples that were generated with various streams of data under different channel circumstances and possessing certain statistical features were used for training in an offline manner. The second phase, online deployment, produces outputs that recover/predict the information sent without requiring an explicit estimate of the wireless channel. Figure 3 shows the steps taken in creating training datasets and utilizing offline DL to develop a trained CNN model.

During the offline training phase, the training dataset for one subcarrier is created by transmitting OFDM frames across the selected channel model. An efficient training dataset requires both the initially transmitted symbols and the OFDM signals at the receiver, which are affected by the actual channel parameters and noise. The proposed DL model, which was trained offline, is then deployed online, where it takes the unknown received signals as input and recovers the broadcast signals by using both the learned information and CNN's inherent ability for automated recognition/extraction of important characteristics.

5. Simulation Results

Several simulations have been performed to prove our suggested CNN structure can effectively estimate the channel and retrieve transmitted symbols. In this section, the proposed CNN framework's SER versus SNR performance is compared to that of the standard LS and MMSE estimation methods, as well as the DL BiLSTM model employed in [23, 24]. Three cycle prefix lengths (16, 8, and 0) and two pilot densities (64 and 8) will be utilized to assess how well the estimator's work. In addition, the proposed CNN model will employ the cross-entropy loss function in the last classification layer during training with the Adam optimizer. In the present research, the recommended CNN model is trained offline utilizing the created data sets and then used to implicitly estimate the CSI/recover the information sent in an OFDM wireless communication system. In the training data set, only one subcarrier is presented. Each OFDM packet includes one

pilot symbol along with a single data symbol. Out of a total of 10,000 OFDM packets, 80 percent are used for learning, while the other 20 percent are used for checking. Table 2 lists the configuration settings for the OFDM system under consideration, whereas Table 3 lists the configuration parameters for the proposed DL CNN model.

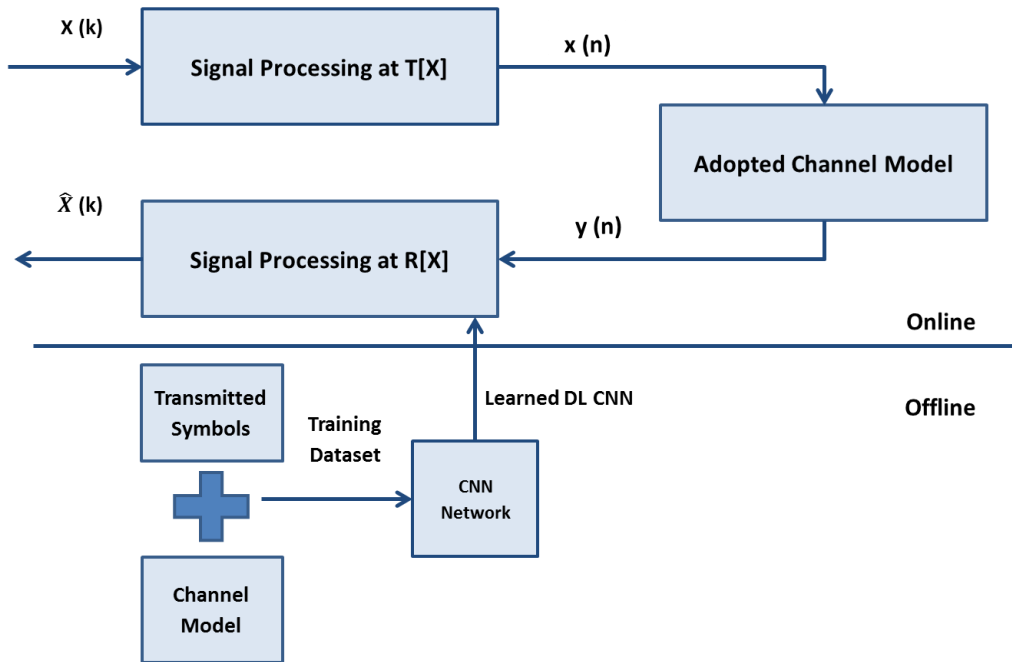

Fig.3. Offline DL procedure/training data set generation of the proposed CNN model.

Table 2: Channel model and OFDM system settings

Parameter	Specifications
Mode of Modulation	Quadrature phase shift keying (QPSK)
Carrier Frequency	2.6 GHz
Number of OFDM subcarriers	64
Number of OFDM blocks	2 OFDM blocks for pilots and symbols, respectively
Size of DFT/IDFT	64
Number of Pilots	64,8
Length of Cyclic Prefix (CP)	16, 8, 0
Model of the Channel	Rayleigh Fading
Number of Paths	24
Model of Noise	Additive white Gaussian noise (AWGN)

Table 3: The proposed DL CNN architecture and the training parameters

Parameter	Specifications
Depth of CNN model	11 Layers
Input Layer Size	256
Convolution Layers (CL) Size	32 kernels of size [64,1], 175 kernels of size [64,1]
FC Layer Size	4
Number of Epochs	8
Mini Batch Size	32
Optimizer	Adam
Loss Function	Cross-entropy

With a sufficient number of pilots (64) and a CP length of 16, as shown in Fig. 4, the proposed DL CNN-based CSE significantly exceeds the conventional estimators at all levels of SNR. On the other hand, in the low SNR region of 0–4 dB, the proposed CNN estimator performs similarly to its counterpart, the DL BiLSTM model used in [23, 24]. In addition, starting at 5 dB, the proposed DL CNN model provides more accurate estimates than the DL BiLSTM model.

Figure 5 illustrates that for a CP of 8, the proposed DL CNN model works similarly to the conventional channel estimators and the DL BiLSTM model in the SNR ranges of 0–4 dB and 0–14 dB, respectively. At a dB level of 5 or subsequently, the proposed DL CNN model outperforms the standard LS and MMSE estimators. In addition, beginning at 15 dB, the suggested DL CNN model provides superior results compared to the DL BiLSTM model. In contrast, the conventional LS estimator is the least effective.

In the simulation scenario with 64 pilots without CP, the proposed DL CNN-based CSE performs significantly better than the other estimators. This can be seen in Fig. 6. The results also demonstrate that in the 0–15 dB SNR bands, the MMSE estimator and the BiLSTM model perform similarly. Moreover, the MMSE estimator beats the BiLSTM model over SNR ranges of 16–27 dB. However, the LS estimator is still the least effective.

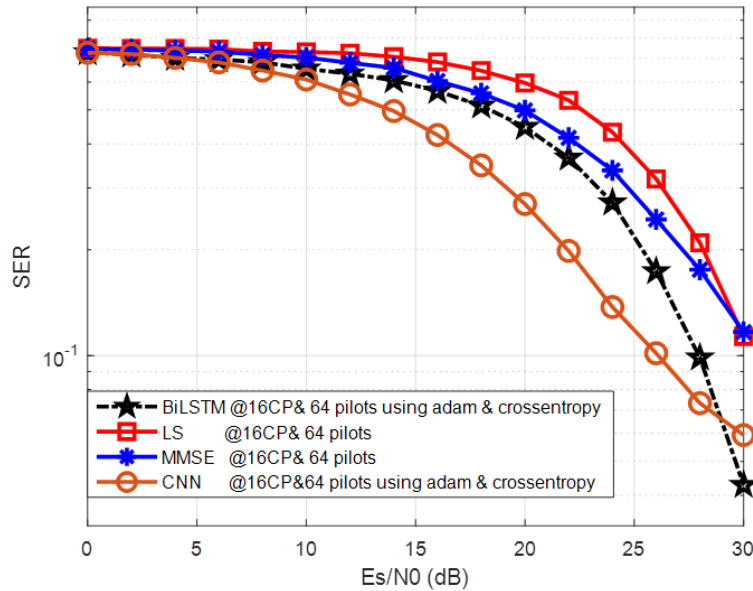

Fig. 4: The SER curves for the performance of the suggested DL CNN structure and the tested estimators at 64 pilots and 16 CP lengths utilizing the Adam optimizer/cross-entropy loss function.

Figures 4, 5, and 6 illustrate that the LS estimator consistently provides the worst SER performance because its estimating method is not dependent on any previous knowledge of channel parameters. In contrast, the MMSE estimator outperforms the LS estimator thanks to its usage of second-order channel statistics. In all simulation scenarios, our suggested DL CNN-based CSE achieved higher SER performance than the two benchmark approaches and the DL BiLSTM model employed in [23], [24]. As a result, the proposed DL CNN model is efficient in both CSE and symbol detection. Also, it demonstrates that the suggested DL CNN structure with the short/no CP is both reliable and robust. The proposed CNN model is more effective because it retains critical data during training while benefiting from its attractive features like weight sharing, local connections, and down sampling dimension reduction.

The behavior of the estimating methods is shown in Fig. 7, with a restricted number of pilots (8) and a CP length of 16. The proposed DL CNN-based CSE beats conventional estimation methods. Furthermore, compared to the DL BiLSTM model, the proposed DL CNN-based CSE performs similarly over the SNR ranges 0–21 dB, as seen in this figure. On the other hand, the channel information cannot be accurately estimated by either LS or MMSE.

When the length of CP is reduced to 8, the proposed DL CNN-based CSE exceeds the standard channel estimation algorithms. Also, the proposed DL CNN estimator and the DL BiLSTM model achieve the same performance across the 0–21 dB SNR ranges, as shown in Fig. 8. In contrast, the standard estimators lose their effectiveness starting at 0 db.

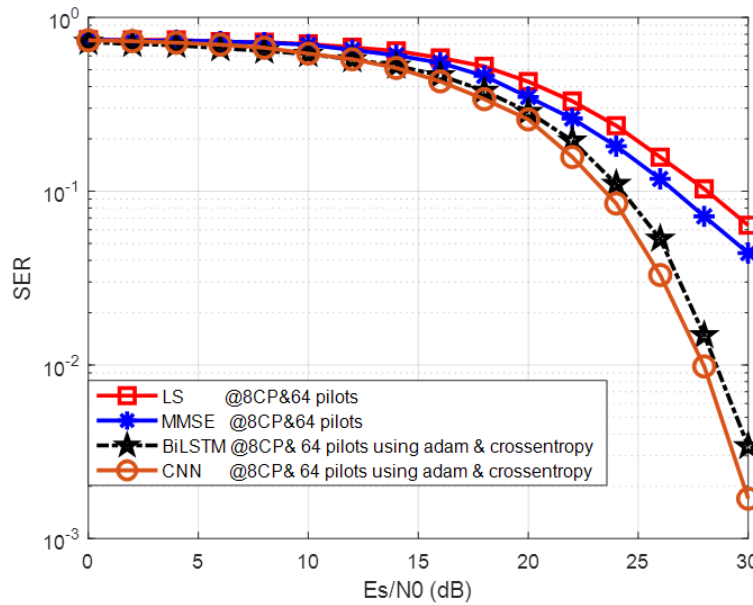

Fig. 5: The SER curves for the performance of the suggested DL CNN structure and the tested estimators at 64 pilots and 8 CP lengths utilizing the Adam optimizer/cross-entropy loss function.

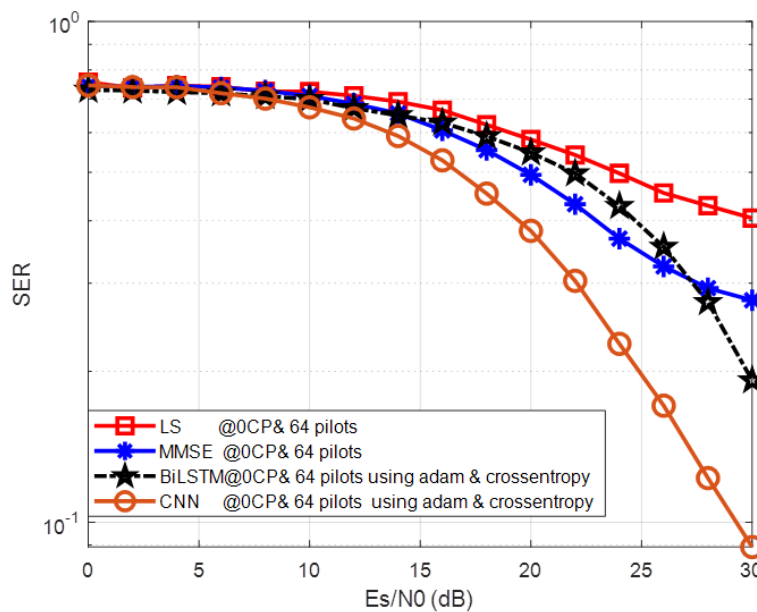

Fig. 6: The SER curves for the performance of the suggested DL CNN structure and the tested estimators at 64 pilots and without CP utilizing the Adam optimizer/cross-entropy loss function.

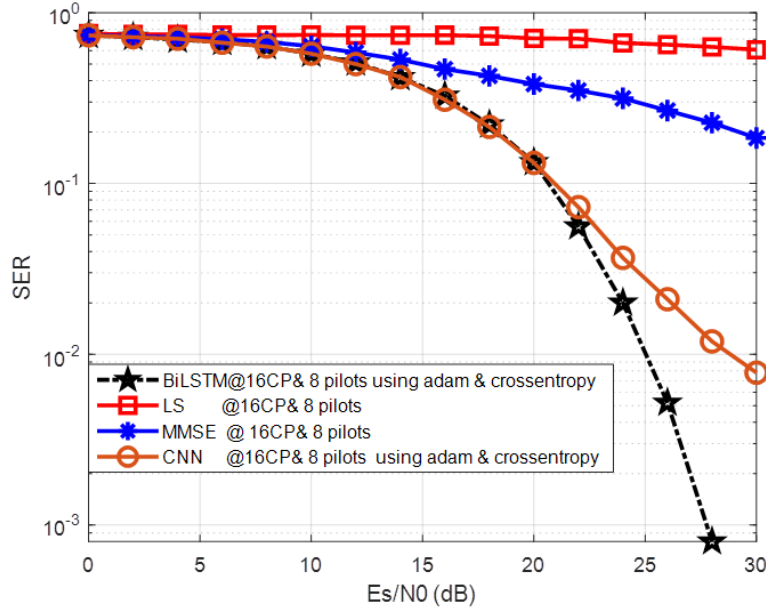

Fig. 7: The SER curves for the performance of the suggested DL CNN structure and the tested estimators at 8 pilots and 16 CP lengths utilizing the Adam optimizer/cross-entropy loss function.

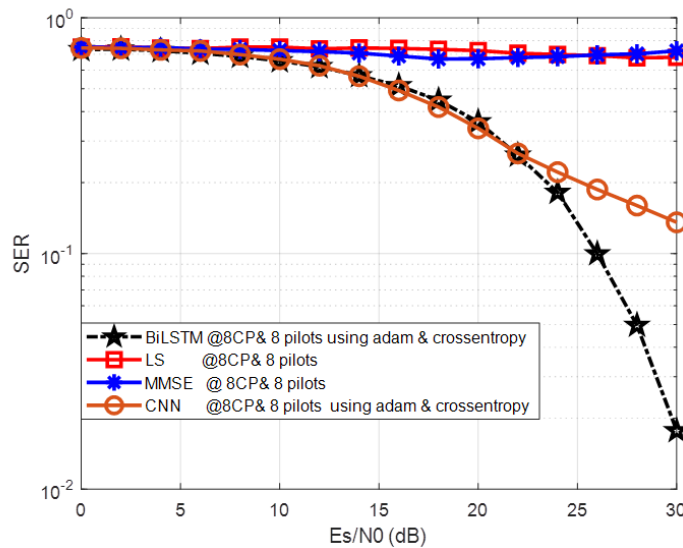

Fig. 8: The SER curves for the performance of the suggested DL CNN structure and the tested estimators at 8 pilots and 8 CP lengths utilizing the Adam optimizer/cross-entropy loss function.

Figure 9 demonstrates that the proposed DL CNN-based CSE outperforms the traditional estimators even in a simulation scenario with 8 pilots and no CP. In addition, the proposed DL CNN structure and the DL BiLSTM model obtain identical performance across the 0–21 dB SNR range. On the other hand, the MMSE performs better in terms of SER performance than the LS estimator, which achieves the worst performance.

At high SNR, almost above 22 dB, the DL BiLSTM beats the proposed DL CNN-based CSE in Figures 7–9. Bi-LSTM's ability to analyze input sequences in both directions and employ past/future time steps gives it this advantage. This bidirectional background can be helpful in high SNR regions where channel behavior may exhibit predictable patterns over time. In addition, Bi-LSTM retains relevant information over time and filters out noise/irrelevant information, making it

efficient at handling noisy data. The results of the performance for the proposed DL CNN-based CSE with 8 pilots and CP lengths of 16, 8, and 0 are summarized in Fig. 10. The proposed DL CNN structure with short/no CP achieves the same performance across (0–7 dB) SNRs, proving its efficacy at lower SNR levels. In addition, the proposed DL CNN model with CP exhibits less variation across the SNR ranges (8–14 dB) than its counterpart without CP.

Based on the obtained results, we can conclude that the proposed DL CNN-based CSE is effective in a short/no CP scenario and is also resistant to limited pilots. This advantage is essential for the DL CSE to be executed in real-time, as identical performance can be achieved with a significant reduction in calculations. Moreover, the suggested DL CNN architecture with low spectrum utilization for CSE/SD is recommended for OFDM wireless communication systems to considerably enhance their energy/spectrum efficiency as well as transmission data rates.

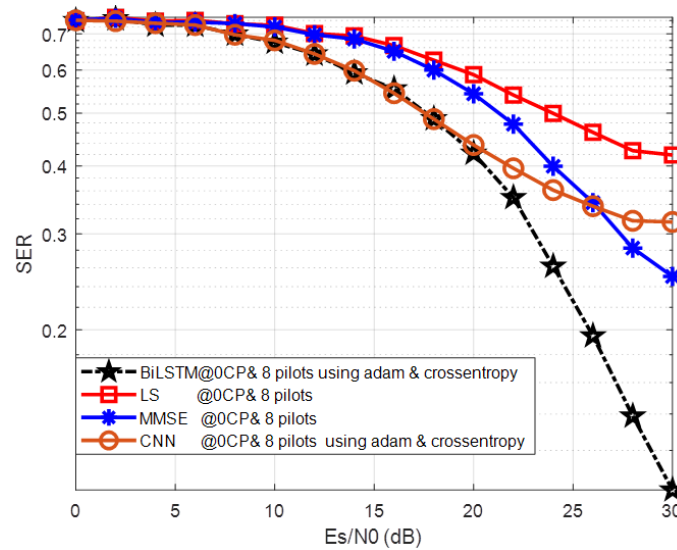

Fig. 9: The SER curves for the performance of the suggested DL CNN structure and the tested estimators at 8 pilots and without CP utilizing the Adam optimizer/cross-entropy loss function.

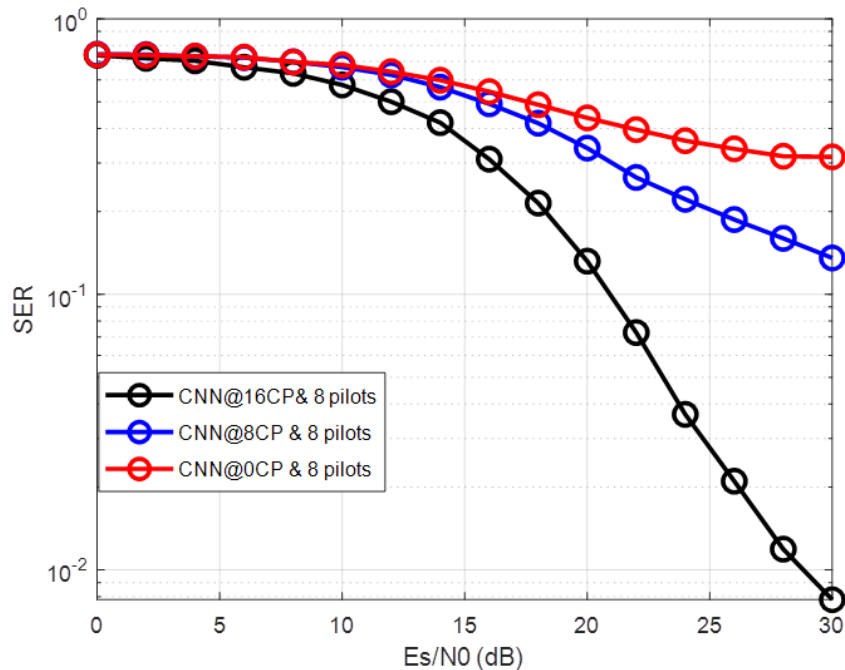

Fig. 10: The SER curves for the performance of the suggested DL CNN structure at 8 pilots and different CP lengths of 16, 8, and 0 utilizing the Adam optimizer/cross-entropy loss function.

5. Conclusions

Improving the performance of multi-carrier wireless communication systems requires efficient channel estimates/accurate signal detection. This study has introduced an efficient/reliable DL framework that leverages CNNs for CSE and signal detection tasks within OFDM wireless systems. Notably, this is the first time, as far as the authors know, that CNN-based CSE has been presented and evaluated without the addition of other complex deep neural network approaches that use short or no CPs. Before extracting/retrieving transmitted data symbols, the proposed DL CNN framework was trained offline using OFDM signals exposed to various channel faults.

Multiple experiments have been conducted to evaluate the suggested CNN framework and demonstrate its efficacy for CSE and signal detection applications compared to the standard LS and MMSE estimation methods and the DL-based BiLSTM model. The simulation results demonstrated that, in all simulated scenarios, the recommended DL CNN CSE showed superior SER performance in symbol detection compared to the conventional LS and MMSE estimators. Additionally, the proposed CNN architecture outperformed the DL BiLSTM model, particularly when a large enough number of pilots were used.

Furthermore, the simulation results confirmed the proposed DL CNN framework's robustness and demonstrated its ability to adapt to a shorter CP length and fewer pilots than conventional methods. Consequently, the proposed DL CNN architecture shows significant potential for CSI estimation/signal detection tasks in OFDM wireless communication systems, thanks to its data-driven approach and its inherent properties of automatically identifying/extracting relevant features. In addition, it lacks the use of previous channel information. The proposed DL CNN model will be employed in future work to apply to more complex system models, such as MIMO scenarios.

References

- [1] Parikh, Jolly, and Anuradha Basu, "Technologies assisting the paradigm shift from 4g to 5g", *Wireless Personal Communications*, vol. 112, pp. 481-502, 2020.
- [2] Shaik, Nilofer, and Praveen Kumar Malik, "A comprehensive survey 5G wireless communication systems: open issues, research challenges, channel estimation, multi carrier modulation and 5G applications", *Multimedia Tools and Applications*, vol. 80, no.19, pp. 28789-28827, 2021.
- [3] Drakshayini, M. N., and Manjunath R. Kounte, "A review of wireless channel estimation techniques: challenges and solutions", *International Journal of Wireless and Mobile Computing*, vol. 23, no.2, pp.193-203, 2022.
- [4] Ijiga, Owoicho E., et al., "Review of channel estimation for candidate waveforms of next generation networks", *Electronics*, vol. 8, no .9, pp. 956, 2019.
- [5] Vilas Boas, Evandro Cesar et al., "Artificial intelligence for channel estimation in multicarrier systems for B5G/6G communications: a survey", *EURASIP Journal on Wireless Communications and Networking*, pp. 1-63, 2022.
- [6] Changqing Luo., et al., "Channel State Information Prediction for 5G Wireless Communications: A Deep Learning Approach", *IEEE Transactions on Network Science and Engineering*, vol. 7, pp. 227-236, 2020.
- [7] M. B. Sutar and V. S. Patil, "LS and MMSE estimation with different fading channels for OFDM system", *Proc. Int. Conf. Electron. Commun. Aerosp. Technol. (ICECA)*, vol. 1, pp. 740-745, 2017.
- [8] Sure, Pallaviram, and Chandra Mohan Bhuma, "A survey on OFDM channel estimation techniques based on denoising strategies", *Engineering Science and Technology, an International Journal*, vol. 20, no. 2, pp. 629-636, 2017.

- [9] Zhu, Guangxu, et al., "Toward an intelligent edge: Wireless communication meets machine learning", *IEEE communications magazine*, vol. 58, no.1, pp.19-25, 2020.
- [10] Tanveer, Jawad, et al., "Machine learning for physical layer in 5G and beyond wireless networks: A survey", *Electronics*, vol.11, no.1, pp. 121, 2022.
- [11] Huang, Hongji, et al., "Deep learning for physical-layer 5G wireless techniques: Opportunities, challenges and solutions", *IEEE Wireless Communications*, vol. 27, no. 1, pp. 214-222, 2019.
- [12] He, Hengtao, et al., "Model-driven deep learning for physical layer communications", *IEEE Wireless Communications*, vol. 26, no. 5, pp. 77-83, 2019.
- [13] Alzubaidi, Laith, et al., "Review of deep learning: Concepts, CNN architectures, challenges, applications, future directions", *Journal of big Data*, vol. 8, pp.1-74, 2021.
- [14] Song, Peng, Chaoyang Geng, and Zhijie Li, "Research on text classification based on convolutional neural network", IEEE International conference on computer network, electronic and automation (ICCNEA), pp. 229-232, 2019.
- [15] Bhatt, Dulari, et al., "CNN variants for computer vision: history, architecture, application, challenges and future scope", *Electronics*, vol. 10, no. 20, pp. 2470, 2021.
- [16] Tripathi, Milan, "Analysis of convolutional neural network-based image classification techniques", *Journal of Innovative Image Processing (JIIP)*, vol. 3, no. 2, pp. 100-117, 2021.
- [17] Van Luong, Thien, et al., "Deep learning based successive interference cancellation for the non-orthogonal downlink", *IEEE transactions on vehicular technology*, vol. 71, no.11, pp.11876-11888, 2022.
- [18] Peng, Shengliang, Shujun Sun, and Yu-Dong Yao, "A survey of modulation classification using deep learning: Signal representation and data preprocessing", *IEEE Transactions on Neural Networks and Learning Systems*, vol. 33, no.12, pp.7020-7038, 2021.
- [19] Logins, Alvis, Jiale He, and Kirill Paramonov, "Block-Structured Deep Learning-Based OFDM Channel Equalization", *IEEE Communications Letters*, vol. 26, no. 2, pp. 321-324, 2021.
- [20] Jdid, Bachir, et al., "Machine learning based automatic modulation recognition for wireless communications: A comprehensive survey", *IEEE Access*, vol. 9, pp. 57851-57873, 2021.
- [21] Zhang, Wenhan, et al., "Signal detection and classification in shared spectrum: A deep learning approach", *IEEE INFOCOM 2021-IEEE Conference on Computer Communications*, pp. 1-10, 2021.
- [22] Bobrov, Evgeny, et al., "Massive MIMO adaptive modulation and coding using online deep learning algorithm", *IEEE Communications Letters*, vol. 26, no.4, pp. 818-822, 2021.
- [23] S. Wang, R. Yao, T. A. Tsiftsis, N. I. Miridakis and N. Qi, "Signal Detection in Uplink Time-Varying OFDM Systems Using RNN With Bidirectional LSTM", *IEEE Wireless Communications Letters*, vol. 9, no. 11, pp. 1947-1951, Nov. 2020.
- [24] A. K. Nair and V. Menon, "Joint Channel Estimation and Symbol Detection in MIMO-OFDM Systems: A Deep Learning Approach using Bi-LSTM," *14th International Conference on Communication Systems & NETworkS (COMSNETS)*, pp. 406-411, 2022.
- [25] A. K. Gizzini, M. Chafii, A. Nimr and G. Fettweis, "Deep Learning Based Channel Estimation Schemes for IEEE 802.11p Standard", *IEEE Access*, vol. 8, pp.113751-113765, 2020.
- [26] Liao, Yong, et al., "ChanEstNet: A deep learning based channel estimation for high-speed scenarios", in Proc. IEEE Int. Commun. Conf. (ICC), Shanghai, China, May 2019, pp. 1-6.
- [27] Mohammed, Aliaa Said Mousa, et al., "Deep Learning Channel Estimation for OFDM 5G Systems with Different Channel Models", *Wireless Personal Communications*, vol. 128, no.4, pp. 2891-2912, 2023.
- [28] Le. Ha. An, et al, "Deep learning-aided 5G channel estimation", *15th international conference on ubiquitous information management and communication (IMCOM)*, IEEE, 2021, pp. 1-7.
- [29] H. A. Le, T. Van Chien, T. H. Nguyen, H. Choo and V. D. Nguyen, "Machine learning-based 5G-and-beyond channel estimation for MIMO-OFDM communication systems", *Sensors*, vol. 21, no. 14, pp. 4861, 2021.
- [30] Honkala, Mikko, Dani Korpi, and Janne MJ Huttunen, "DeepRx: Fully convolutional deep learning receiver", *IEEE Transactions on Wireless Communications*, vol.20, no.6, pp.3925-3940, 2021.

- [31] M. H. Essai Ali, M. L. Rabeh, S. Hekal and A. N. Abbas, "Deep learning gated recurrent neural network-based channel state estimator for OFDM wireless communication systems", *IEEE Access*, vol. 10, pp. 69312-69322, 2022.
- [32] S. R. Mattu and A. Chockalingam, "Learning-based channel estimation and phase noise compensation in doubly-selective channels", *IEEE Commun. Lett.*, vol. 26, no. 5, pp. 1052-1056, May 2022.
- [33] S. Ponnaluru, and S. Penke, "Deep learning for estimating the channel in orthogonal frequency division multiplexing systems", *Journal of Ambient Intelligence and Humanized Computing*, vol. 12, no. 5, pp. 5325-5336, 2020.
- [34] Yi, Xuemei, and Caijun Zhong, "Deep learning for joint channel estimation and signal detection in OFDM systems", *IEEE Communications Letters*, vol. 24, no. 12, pp. 2780-2784, 2020.
- [35] Hatcher, William Grant, and Wei Yu, "A survey of deep learning: Platforms, applications and emerging research trends", *IEEE Access*, vol. 6, pp. 24411-24432, 2018.
- [36] Zhou, Ding-Xuan, "Theory of deep convolutional neural networks: Downsampling", *Neural Networks*, vol.124, pp.319-327, 2020.
- [37] M. H. Essai, et al., "Machine Learning-Based Channel State Estimators for 5G Wireless Communication Systems", *CMES-COMPUTER MODELING IN ENGINEERING & SCIENCES*, vol. 135, no. 1, pp. 755-778, 2023.
- [38] Hassan A. Hassan, et al., "Effective deep learning-based channel state estimation and signal detection for OFDM wireless systems", *Journal of Electrical Engineering*, vol.74, no.3, 3923, pp.167-176, 2023.

مُقَدِّر حالة قناة OFDM الفَعَال والموثوق باستخدام الشبكات العصبية التلافيفية للتعلم العميق

تعتمد الأنظمة اللاسلكية لتعدد الإرسال بتقسيم التردد المتعامد (OFDM) بشكل كبير على تقدير حالة القناة (CSE) للتخفيف من آثار تلاشي القناة المتعدد المسارات. يتطلب تحقيق معدل بيانات مرتفع باستخدام تقنية OFDM إجراء عملية CSE فعالة واكتشاف دقيق للإشارة. على النقيض من أساليب CSE التقليدية التي تعتمد على استراتيجيات قائمة على النماذج، اجتذبت تقنيات CSE المستندة إلى التعلم الآلي (ML) اهتمامًا متزايدًا في السنوات الأخيرة بسبب مرونتها المستندة إلى البيانات والتعلم. في هذا السياق، يتم استخدام شبكة عصبية تلافيفية للتعلم العميق (DL) للحصول على CSE موثوق به عبر قنوات تلاشي رايلي للنظام اللاسلكي OFDM. يستخدم مُقدر حالة القناة المقترح التدريب دون اتصال بالإنترنت لجمع معلومات القناة من أزواج الإرسال/الاستقبال. وبالإضافة إلى ذلك، فإنه يستخدم إشارات توجيهية لتقديم إرشادات إضافية بشأن قنوات الاتصال. بالمقارنة مع أساليب التقدير التقليدية، يُظهر مُقدر حالة القناة المقترح القائم على CNN تحسن كبير في النتائج التجريبية. بالإضافة إلى ذلك، فإن نموذج CNN المدرب يعمل بشكل أفضل من مُقدرات قنوات DL الحديثة. تؤكد نتائج المحاكاة أيضًا أن مُقدر حالة القناة المقترح القائم على CNN فعال عندما يكون هناك عدد أقل من الإشارات التوجيهية، مع / بدون بادئات الدورة (CP)، وهذا يقلل من عرض النطاق الترددي المطلوب لنقل لكمية نفسها من البيانات. بالإضافة إلى ذلك، لا توجد معرفة أساسية بإحصائيات القناة في مُقدر حالة القناة المقترح. ومن ثم، تُظهر الطريقة المقترحة إمكانية معالجة مشكلات CSE في أنظمة OFDM مع تخفيض كبير في موارد الطيف.